

NetSure™ ACU+ (Advanced Control Unit Plus)

User Instructions, UM1M820BNA (Issue AH, March 4, 2013)

Specification Number: 1M820BNA, 1M820DNA

Model Number: M820B, M820D

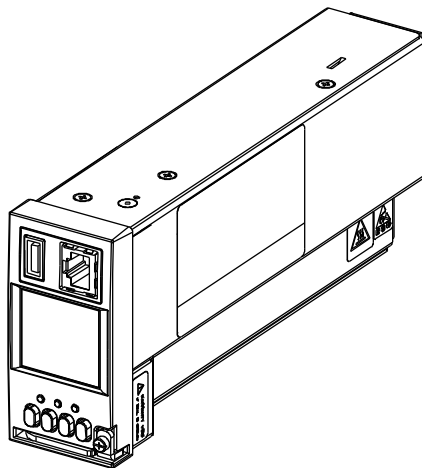

Model M820B

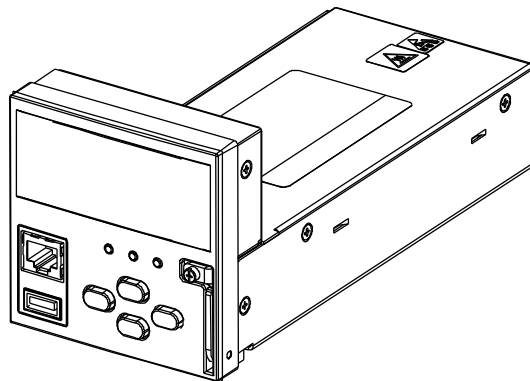

Model M820D

This page is intentionally blank.

TABLE OF CONTENTS

Chapter 1. Introduction	1
1.1 Preface	1
1.2 Overview.....	1
1.3 Function Descriptions.....	2
1.3.1 Rectifier Control.....	2
1.3.2 Converter Control	2
1.3.3 System Components Monitoring and System Alarms Generation	3
1.3.4 Operating Data Acquisition and Data Logs	3
1.3.5 Battery Management	4
1.3.6 Intelligent Power Matching (Energy Optimization Mode)	8
1.3.7 Power Split Feature	9
1.3.8 Diesel Management Feature	9
1.3.9 PLC (Programmable Logic Controller) Function	10
1.3.10 Supervisory Module (SM Modules) Monitoring	10
1.3.11 Hybrid Control Function.....	10
1.3.12 Maximum Current Limit Function.....	15
Chapter 2. Operation	16
2.1 Local Indicators	16
2.2 Passwords and Access Levels.....	17
2.3 Local Keypad and Display Access	18
2.3.1 Local Menu Navigation Keys and LCD Display.....	18
2.3.2 Local Display Menus	18
2.4 WEB Interface Access.....	19
2.4.1 Overview.....	19
2.4.3 WEB Interface Menus.....	19
2.4.4 Connecting the Controller Locally (via the Ethernet Port)	19
2.4.5 Disabling Proxy Server Settings to Enable a Connection to the Controller over an Intranet Network (if required)	20
2.4.6 Logging into the Controller	21
2.5 Common Tasks Performed via the Local Keypad and/or Web Interface.....	22
2.5.1 Backing Up the Configuration.....	22
2.5.2 Reloading a Backed-Up Configuration	22
2.5.3 Reloading the Configuration File Stored in the ACU+ Controller	22
2.5.4 Downloading a Configuration or an Application ("All") Package into the ACU+ Controller	23
2.5.5 Rebooting the Controller.....	24
2.5.6 Changing the Local LCD Display Contrast.....	24
2.5.7 Disabling the Local Keypad Sound	24
2.5.8 Changing the Date.....	24
2.5.9 Changing the Time	24
2.5.10 Adding, Deleting, and Modifying Users	24
2.5.11 Assigning Severity Level to Alarms	24

2.5.12	Assigning Relays to Alarms	25
2.5.13	Changing the Names of Items Displayed in the LCD and Web-Interface Menus	25
2.5.14	Viewing Alarms	25
2.5.15	Clearing Rectifier Lost, Rectifier Communication Fail, Converter Lost, Converter Communication Fail, and All Converter Comm Fail Alarms	25
2.5.16	Clearing SMTemp Lost and SMTemp Probe Alarms	25
2.5.17	Clearing Battery Alarms.....	25
2.5.18	Clearing Logs.....	25
2.5.19	Clearing the Maintenance Alarm	26
2.5.20	Viewing the ACU+ Controller's Device Inventory	26
2.5.21	Updating the ACU+ Controller's Device Inventory	26
2.5.22	Programming the Audible Alarm Feature	26
2.5.23	Blocking Alarms	26
2.5.24	Configuring the ACU+ Identification of Rectifiers and Assigning which Input Phase is Connected to the Rectifiers	27
2.5.25	Configuring the ACU+ Identification of Converters	28
2.5.26	Viewing/Changing the Float Voltage Setting	29
2.5.27	Viewing/Changing the Equalize Voltage Setting	29
2.5.28	Setting Digital Inputs.....	29
2.5.29	Setting Temperature Sensors.....	29
2.5.30	Setting Battery Charge Temperature Compensation	30
2.5.31	Setting Auto Equalize	30
2.5.32	Setting Battery Parameters	31
2.5.34	Setting Battery Block and Battery Midpoint Monitoring (if equipped with an EIB Assembly)	31
2.5.35	Setting IP Communications Parameters	31
2.5.36	Setting External Shunts (connected to the EIB Assembly)	31
2.5.37	Setting External Shunts (connected to the SM-DU+ Assembly)	31
2.5.38	Setting the Load Current Alarm.....	32
2.5.39	Placing the System in Float or Equalize Charge Mode	32
2.5.40	Manually Forcing Relays	32
2.5.41	Manually Forcing LVDs	32
2.5.42	Using the Relay Test Feature.....	33
2.5.43	Spec. No. 588820300 Battery Rack System (Lithium Ion Battery Configuration).....	34
2.6	Available Alarms.....	35
2.7	Power Split Feature	73
2.7.1	Overview.....	73
2.7.2	How Power Split Works	73
2.7.3	Operating Modes	74
2.7.4	Requirements and Conditions	74
2.7.5	Paralleling the Existing and ACU+ Power Systems	75
2.7.6	Programming the ACU+ Power Split Feature	77
2.7.7	Verifying the Operation of the Power Split Feature	79
Chapter 3.	Local Display Menus.....	80
3.1	Overview.....	80

3.2	Menus.....	80
3.2.1	Adjustment Range Restrictions	81
3.3	Description of Local Display (and Web Interface) Menus Line Items	92
3.3.1	Settings Menu.....	92
3.3.2	ECO Mode (Energy Optimization) Menu.....	106
3.3.3	Manual Menu	106
3.3.4	Quick Setting Menu	109
Chapter 4.	WEB Interface Menus.....	113
4.1	Overview.....	113
4.2	Homepage.....	113
4.3	Menu Navigation Window.....	115
4.3.1	Alarms.....	116
4.4	Device Information Menu	118
4.4.1	Rectifier Group.....	118
4.4.2	Battery Group (except Li-Ion Battery Configuration)	123
4.4.3	Battery Group (Li-Ion Battery Configuration)	128
4.5	Quick Settings Menu	130
4.6	Query Menu.....	131
4.6.1	Alarm History Log Sub-Menu	131
4.6.2	Data History Log Sub-Menu	132
4.6.3	Control/System/Diesel Log Sub-Menu	133
4.6.4	Battery Test Log Sub-Menu.....	134
4.7	Maintenance Menu.....	135
4.7.1	Network Configuration Sub-Menu	135
4.7.2	NMS (Network Management System) Configuration Sub-Menu.....	136
4.7.3	HLMS (High Level Management System) Configuration Sub-Menu.....	137
4.7.4	Edit PowerSplit Sub-Menu.....	138
4.7.5	User Information Settings Sub-Menu	139
4.7.6	Clear Data Sub-Menu	141
4.7.7	Restore Factory Defaults Sub-Menu	142
4.7.8	Download Sub-Menu	143
4.7.9	Retrieve 'SettingParam.run' File Sub-Menu	145
4.7.10	Time Sync Sub-Menu	146
4.7.11	System Inventory Sub-Menu	147
4.8	Configuration Menu	148
4.8.1	Auto Configuration Sub-Menu	148
4.8.2	Site Information Modification Sub-Menu	149
4.8.3	Equipment Information Modification Sub-Menu	150
4.8.4	Signal Information Modification Sub-Menu.....	151
4.8.5	Alarm Suppressing Sub-Menu.....	153
4.8.6	PLC Sub-Menu	155
4.8.7	Alarm Relay Sub-Menu	158

Chapter 5. Accessing the Controller via a Network Management System (NMS)	159
5.1 General.....	159
5.2 NMS Supported by SNMP Agent	159
5.3 MIB Installation	159
5.3.1 Installation.....	159
5.3.2 Contents of the Controller's MIB.....	159
5.4 Accessing the Controller through an NMS	163
5.4.1 Apply Administrative Authority.....	163
Chapter 6. Replacement Procedures	164
6.1 ACU+ Controller Replacement.....	164
Chapter 7. Specifications.....	166
Revision Record	168

CHAPTER 1. INTRODUCTION

1.1 Preface

These instructions describe the complete functionality of the ACU+ Controller. Some functionality is dependent on hardware connected to the ACU+ Controller. Your system may not utilize all the functionality described.

Refer also to the ACU+ Configuration Drawing (C-drawing) furnished with your system for a list of factory default settings.

1.2 Overview

The ACU+ Controller performs the following functions.

- Rectifier Control, including an Energy Optimization Mode
- Converter Control
- System Components Monitoring and System Alarms Generation (including recording alarms in logs)
- Operating Data Acquisition and Data Logs
- Battery Management
- Intelligent Power Matching (Energy Optimization Mode)
- Power Split Feature
- Diesel Management Feature
- PLC (Programmable Logic Controller) Function
- Supervisory Module (SM Modules) Monitoring
- Hybrid Control Function
- Maximum Current Limit Function

The ACU+ controls the system automatically via configured parameters.

A User interfaces with the ACU+ Controller locally using the local keypad and LCD display or locally/remotely using the WEB Interface.

The ACU+ Controller can also be accessed via SNMP (v1 and v2).

Figure 1 illustrates the various methods to interface with the ACU+ Controller remotely.

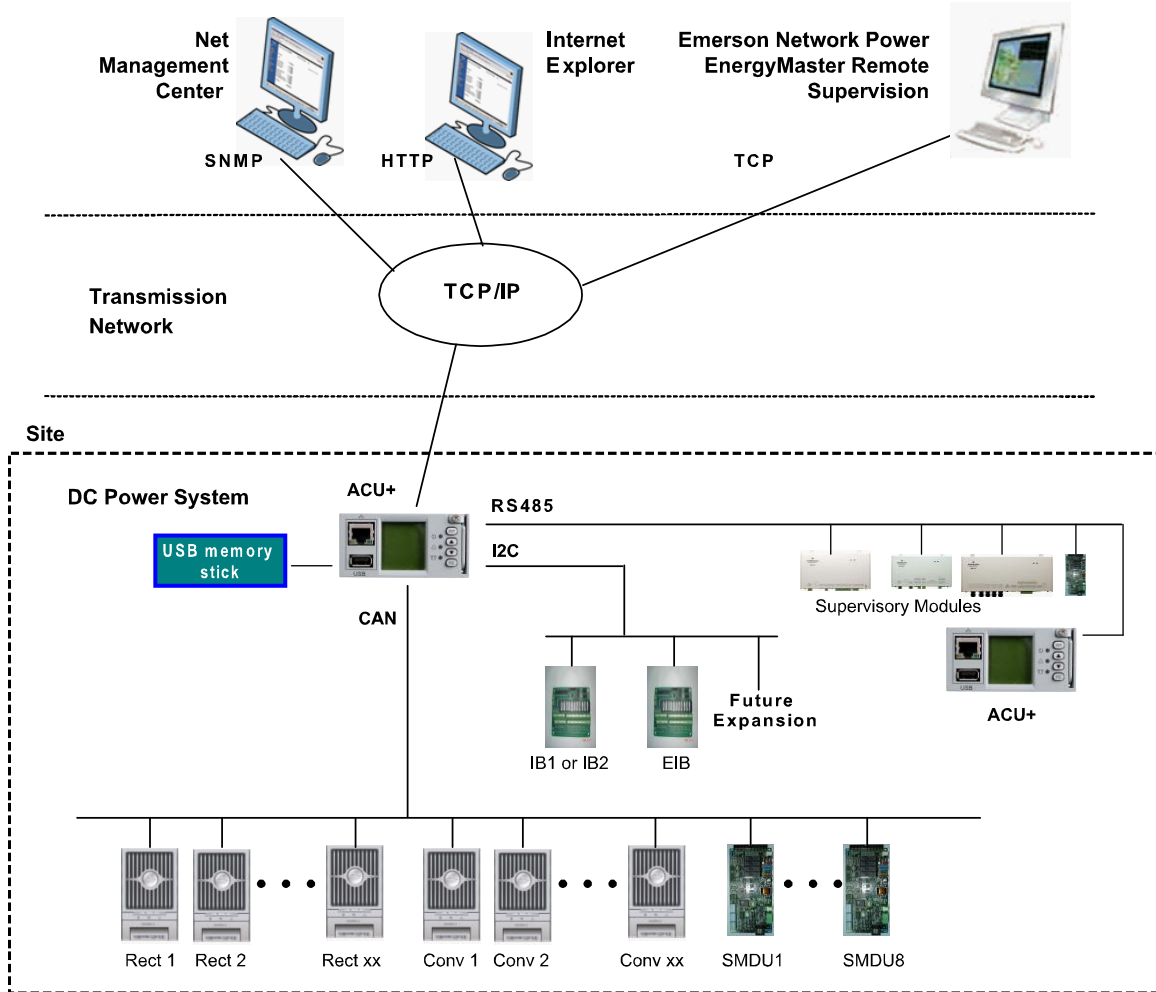

Figure 1
ACU+ Remote Communications

1.3 Function Descriptions

1.3.1 Rectifier Control

Rectifiers are automatically controlled by the ACU+ Controller. The ACU+ Controller provides an Energy Optimization Mode function. Energy Optimization permits an installation to only operate rectifiers as needed to maintain the load and keep batteries in a fully charged condition. As load increases, Energy Optimization turns on additional rectifiers as needed to maintain the load. As load decreases, Energy Optimization places rectifiers in standby to conserve energy usage. Rectifiers which are always operating to maintain any load requirements are cycled through the group of rectifiers controlled by this feature to provide uniform operating times for each rectifier.

1.3.2 Converter Control

Converters are automatically controlled by the ACU+ Controller.

1.3.3 System Components Monitoring and System Alarms Generation

The ACU+ Controller monitors the components comprising the system (such as the rectifiers, converters, and supervisory modules) and generates alarms if a fault condition occurs. The ACU+ Controller also maintains an alarm history log.

The available system alarms are programmed with an Alarm Severity Level. Each Alarm Severity Level has different visual/audible alarm attributes. Available Alarm Severity Levels and their attributes are listed in Table 1.

Alarm Severity Level	ACU+ Red Alarm Indicator	ACU+ Yellow Alarm Indicator	ACU+ Audible Alarm
Critical Alarm (CA)	ON	OFF	ON
Major Alarm (MJ)	ON	OFF	ON
Minor Alarm (MN)	OFF	ON	OFF
No Alarm	OFF	OFF	OFF

Table 1
Alarm Severity Levels

- The alarm indicator turns OFF if the fault(s) that triggered the alarm clears.
- The audible alarm can be silenced by pressing any key on the ACU+ Controller local interface pad. The audible alarm is also silenced if the fault(s) that triggered the alarm clears.
- An audible alarm cutoff feature can be programmed that silences the audible alarm after a pre-set programmable time period. The audible alarm can also be disabled.

The available system alarms can also be mapped to alarm relays (located on ACU+ interface boards) that can be wired to external alarm circuits.

1.3.4 Operating Data Acquisition and Data Logs

The ACU+ Controller acquires and analyses real time data from the system's components such as the rectifiers, converters, and supervisory modules.

The ACU+ Controller uses this data to process alarms and also records data in logs. The logs are viewed using the WEB Interface and consists of...

- Alarm History Log: records 600 latest alarms.
- Data History Log: records 60000 latest history data.
- Control Log: records 500 latest control events.
- System Log: records 3000 latest system events.
- Diesel Test Log: records 500 latest diesel test results.
- Battery Test Log: up to twelve (12) battery discharge tests can be performed and recorded per year.

Note: Once maximum number of log entries is reached, new entries overwrite oldest entries.

Logs can be saved in the text (.txt) format.

1.3.5 Battery Management

General Battery Management

The ACU+ Controller provides the following battery management functions (except Lithium Ion Battery Configuration).

- Battery Charge Temperature Compensation
- Battery Equalize Charge
- Battery Charge Current Limit
- High and Low Battery Temperature Alarms
- Battery Thermal Runaway Management (BTRM) Feature (Reduces Voltage during a High Battery Temperature Condition)
- Battery Discharge Tests
- Battery Test Logs (maximum twelve [12] logs, maximum eighteen [18] battery strings per log)
- Battery LVD (Low Voltage Disconnect)
- Battery Capacity Prediction
- Battery Block and Battery Midpoint Monitoring
- Enhanced Battery Monitoring with SM-BRC
- Thermal Runaway Detection/Management

Spec. No. 588820300 Battery Rack System (Lithium Ion Battery Configuration)

When the ACU+ is equipped with the Lithium Ion Battery Configuration for use with Spec. No. 588820300 NetSure™ Battery Rack System, the battery management functions are as follows.

- The configuration only provides the battery float charge voltage (equalize charging is not applicable).
- The only adjustable battery setting (besides the float voltage level) is the ABCL (Active Battery Charge Current Limit) Point.
- Active Battery Charge Current Limit (ABCL): This feature controls the amount of charge current supplied to the lithium-ion batteries installed in the power plant to prevent failure of the batteries.
- Battery status and alarms sent by the batteries to the ACU+ are displayed in the ACU+ interfaces.
- Refer also to the instructions provided by the battery manufacturer for battery management functions built into the battery itself.

NOTE THAT THE FOLLOWING DESCRIPTIONS ARE FOR THE GENERAL BATTERY MANAGEMENT FUNCTIONS AND DO NOT APPLY TO THE LITHIUM ION BATTERY CONFIGURATION.

Battery Charge Temperature Compensation

The ACU+ Controller can be programmed to automatically increase or decrease system output voltage to maintain battery float current as battery temperature decreases or increases, respectively. Battery life can be extended when an optimum charge voltage to the battery with respect to temperature is maintained. Temperature is monitored by a sensor mounted on the battery. See your power system documentation for temperature sensor information. You can also set High2, High1, and Low compensation temperature alarms.

Functional Description (See Figure 2): Battery charge temperature compensation adds a correction term, related to the temperature of the batteries, to the nominal value of the system voltage. The degree of regulation (TempComp Coeff), expressed in mV/°C/battery string, can be set per battery manufacturer recommendations.

To protect batteries and voltage-sensitive loads, compensation is automatically limited to a maximum of two volts (48V systems) or one volt (24 volt systems) above or below the nominal output level (float setting).

Temperature compensation will also clamp if the voltage reaches either the TEMP COMP MAX V setting or the TEMP COMP MIN V setting. This feature can also be disabled.

Temperature compensation is automatically disabled if communication between the Controller and all rectifiers is lost, a DC over or under voltage alarm activates, a low voltage disconnection occurs, manual mode is entered, or the system enters the boost or test modes.

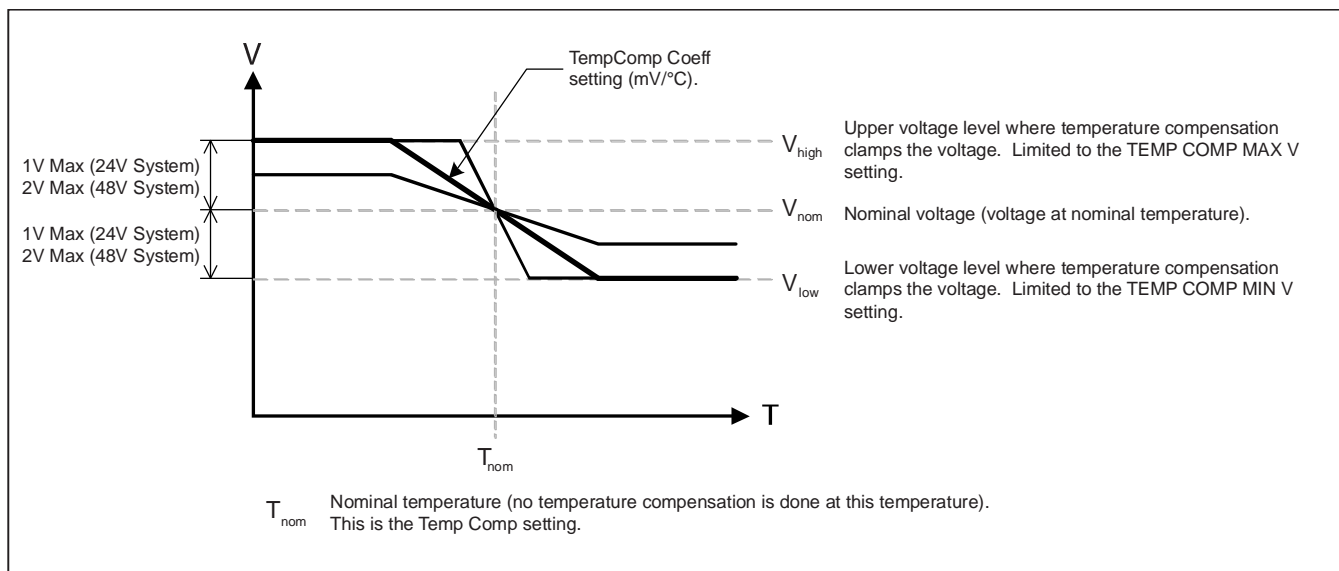

Figure 2
 Temperature Compensated Voltage Control

Battery Equalize Charge and Battery Charge Current Limit

The ACU+ Controller can increase system output voltage for equalizing the charge on all battery cells of a conventional flooded cell battery, or for recharging the battery following a commercial power failure.

The charging function can be initiated cyclically (scheduled), automatically, or manually.

Refer to the battery manufacturer's instructions for equalize charging instructions.

Functional Description (See Figure 3):

- **Start of Charging:** When the battery charge current exceeds a preset value for 3 minutes or if the calculated battery capacity has decreased to a preset value (after a commercial AC failure, for example), the charging function of the ACU+ is activated. A charging signal is sent from the ACU+ to the rectifiers to increase the voltage up to the battery charging level V_{equalize}
- **Battery Current Limitation:** After a commercial AC failure or when some battery cells are permanently damaged, the current to the batteries can be quite extensive. To avoid overheating or further damages to the battery, the ACU+ limits the battery current to a preset level by limiting the charging voltage of the rectifiers. Should the battery current still exceed a higher preset value, an alarm is issued.
- **End of Charging:** When the charging current drops below a preset value, a defined prolonged charging time is started before the charging is stopped and the voltage of the rectifiers return to the float charging level (V_{nom}). For safety, there is a equalize charging limit time that stops the charging after a preset time.

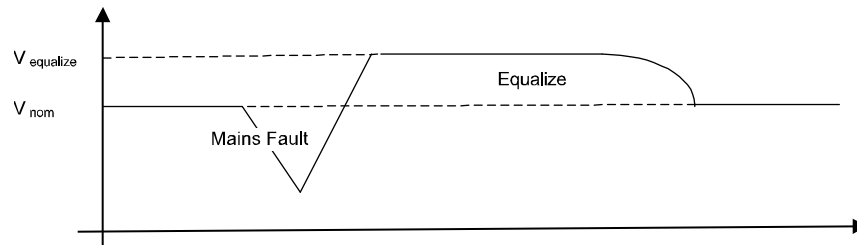

Figure 3
Voltage Characteristics on Commercial AC Failure and Automatic Equalize Charging

High and Low Battery Temperature Alarms

The ACU+ Controller can monitor battery temperature via a temperature sensor mounted on a battery cell. Values for high battery temperature and low battery temperature alarms can then be programmed into the ACU+ Controller.

Battery Thermal Runaway Management (BTRM) Feature

You can designate a temperature sensor as the BTRM sensor. The BTRM sensor has High2 and High1 BTRM temperature alarm limits. If battery temperature exceeds the "BTRM Temp High2" setting, system voltage is lowered to the BTRM voltage setting. This feature can also be disabled.

Battery Discharge Test and Battery Test Logs

The ACU+ Controller can perform battery discharge tests to check the condition of the battery. There are (3) types of battery discharge tests.

- Short Time Test
- Time Test
- Stable Current Test

A User can manually start a battery discharge test or program the ACU+ Controller to automatically start battery discharge tests at scheduled intervals (cyclic battery tests). During a battery discharge test, the ACU+ Controller controls the rectifiers output to place the entire load or partial load on the batteries. The ACU+ Controller monitors the discharge of the battery and saves the results in a battery test log.

Functional Description: For manual battery discharge tests as well as for cyclic battery discharge tests, the following parameters must be set: End Voltage, Test Time, and Battery Capacity Discharge Limit. See Figure 4.

Battery Discharge Test Sequence:

- In time test modes, the output voltage of the rectifiers is reduced so that only the batteries power the load. If the batteries fail, the rectifiers power the load.
- In stable current test mode, the output voltage of the rectifiers is reduced so that the batteries supply the preset test current to the load.
- The battery test continues until one of the following occurs:
 - The preset test time, see Figure 4, expires. The battery has passed the test.
 - The battery voltage drops below the preset end voltage level (V_{end}) (Figure 4). The battery has not passed the test and the test is interrupted. A battery test alarm is activated.
 - The battery capacity drops below the preset test end battery capacity. The battery has not passed the test and the test is interrupted. A battery test alarm is activated.
- After the battery discharge test, the output voltage of the rectifiers increase so that the rectifiers supply the system and charge the batteries.

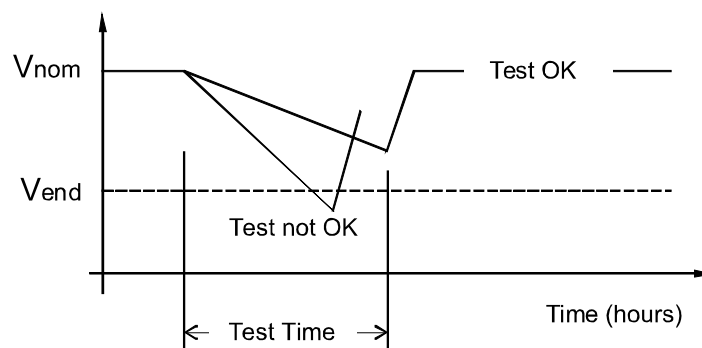

Figure 4
Battery Test Diagram

Battery LVD (Low Voltage Disconnect)

To prevent serious damage to the batteries during a commercial AC power failure, the batteries can be disconnected by voltage or time control.

The batteries are reconnected automatically when commercial AC power is restored and a predetermined DC voltage level is reached.

- **Voltage Controlled Disconnection:** When the set voltage level is reached, the batteries are disconnected.
- **Time Controlled Disconnection:** When the set time has elapsed, the batteries are disconnected.

Battery Capacity Prediction

The ACU+ can predict battery capacity.

Battery Block and Battery Midpoint Monitoring

The ACU+ can monitor battery blocks (12V blocks) or midpoint battery voltage of battery strings connected to the EIB assembly. An alarm is issued when either battery block voltage or battery midpoint voltage is abnormal.

Enhanced Battery Monitoring with SM-BRC

When connected to an SM-BRC, the ACU+ provides enhanced battery monitoring.

Thermal Runaway Detection and Management

Functional Description: The system uses several control mechanisms to avoid thermal runaway.

First: During a short high rate discharge, the batteries will normally get hot. The ACU+ takes this into consideration. After completion of the discharge duty, the batteries are recharged with a limited current to avoid heating the batteries any further.

Second: The temperature of the batteries can be monitored, and the ACU+ sets the charge voltage appropriately, as previously described under Battery Charge Temperature Compensation.

Third: In addition to battery temperature compensation, if battery temperature rises above a set temperature limit, the system stops battery charging completely by lowering the output voltage to the “BTRM Voltage” setting. This allows the batteries to cool down. The system also provides alarm notification of this occurrence. Power supplied to customer equipment is not interrupted.

Fourth: The battery LVD circuits can be programmed to open (disconnect) if a high temperature event occurs (HTD – High Temperature Disconnect). The contactor(s) open when battery temperature rises above a programmable value and close again when battery temperature falls below another programmable value.

1.3.6 Intelligent Power Matching (Energy Optimization Mode)

With Energy Optimization Mode (ECO):

- The Controller monitors load current versus system capacity.
- The Controller commands some rectifiers to standby in rotation.

Refer to “1.3.1 Rectifier Control” for further description.

1.3.7 Power Split Feature

The Power Split feature allows you to connect the power system controlled via the ACU+ to an existing DC power system instead of extending or completely replacing the existing DC power system.

The power system controlled via the ACU+ functions as a slave system to share load (split output) with the existing system (master system) that requires expansion. The ACU+ does not require communication with the master system's Controller.

The Power Split feature provides for the sharing of total load in a controlled manner between the paralleled power systems.

When Power Split is programmed, the ACU+ adjusts rectifier output voltage per load demands to ensure proper sharing between the slave and master power systems. See Figure 5.

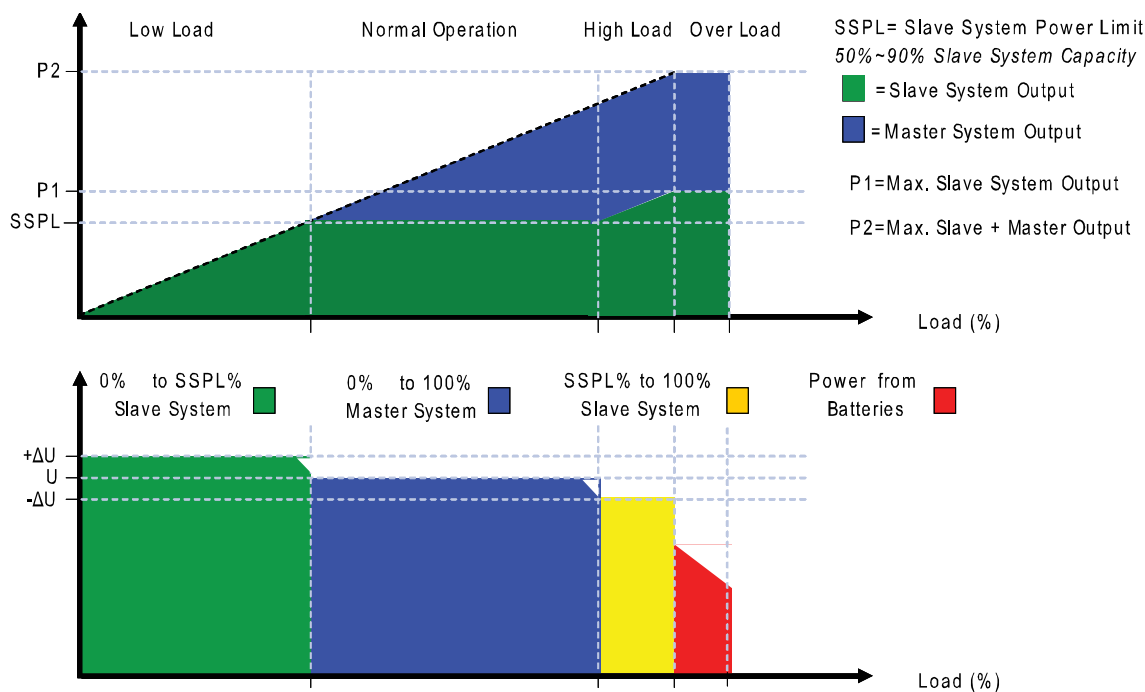

Figure 5
 Power Split Feature

1.3.8 Diesel Management Feature

The Diesel Management feature is available when an SM-AC supervisory module is connected to the ACU+ Controller. The Diesel Management feature consists of a Diesel Test. The Diesel Test can be performed at specific intervals or a User can manually start the Diesel Test. The ACU+ records the test results.

1.3.9 PLC (Programmable Logic Controller) Function

The PLC function allows a User to create "control program lines" by combining equipment analog signals, parameters, and alarms in a sequence that controls equipment and/or operates relays.

Control program lines are created using the WEB Interface. See "4.8.6. PLC Sub-Menu".

Available logical components are:

Logical Component	Description
Logic NOT	NOT; Returns the inverted value of the input signal/parameter.
Logic OR	OR; Returns active (true) if any of the two signals/parameters are active (true).
Logic AND	AND; Returns active (true) if both of the two signals/parameters are active (true).
AndOr	XOR; Returns active (true) if one and only one of the two signals/parameters are active (true).
Greater Than (>)	GREATER THAN; Returns active (true) if the analog input signal goes above the set threshold. Returns inactive (false) if the input signal goes below the set threshold minus hysteresis value.
Less Than (<)	LESS THAN; Returns active (true) if the analog input signal goes below the set threshold. Returns inactive (false) if the input signal goes above the set threshold plus hysteresis value.
Delay	DELAY in seconds; Delays the applied signal/parameter with the defined time in seconds before applying it to the output.

1.3.10 Supervisory Module (SM Modules) Monitoring

Various devices (supervisory modules) can be connected to the ACU+ Controller to extend its monitoring capabilities.

1.3.11 Hybrid Control Function

Hybrid Control is designed for use in new installations or as an upgrade of existing sites powered by a diesel generator(s) when grid power is not available. The Hybrid Control is also applicable to sites with highly unreliable or frequently unavailable grid power connection. The primary power source is still considered to be the diesel generator(s).

Note: *The Hybrid Control function requires a specific configuration. Hybrid Control menus will not normally be displayed unless your ACU+ has been configured by Emerson for this function. Contact Emerson for a Hybrid Control configuration.*

General

Hybrid Control allows the option of selecting one of the following: Fixed Daily Time based operation or Capacity Discharge based operation.

Fixed Daily Time based operation is intended to be used with a combination of AC powered active cooling (air conditioners) and DC powered cooling (heat exchangers, etc). The cycle period is synchronized to the 24hr day-night cycle. It makes optimum use of the different temperature conditions during the day and the night in order to facilitate Hybrid fuel saving operation.

Capacity Discharge based operation is intended for sites utilizing only DC powered cooling (heat exchangers, etc). The cycle period is determined by User selectable depth of discharge (DOD) of the batteries per cycle and associated recharge time. It provides optimum Hybrid fuel saving operation.

Operation from Grid Power is performed with both Fixed Daily Time and Capacity Discharge modes of operation. Grid power is always given priority when available.

As the two types of control are specific to the hardware configuration of the site, the Fixed Daily Time or Capacity Discharge is a User selectable option on installation.

Hybrid Operation

Generator Control: Potential free relay contact output from the ACU+ interface board controls the start and stop of the diesel generator. The signal is generated by the ACU+ Controller and operates according to the Hybrid software mode of operation. The control logic is as follows:

- Energized output relay – Generator OFF.
- De-energized output relay – Generator ON.

This is a fail-safe logic to ensure generator operation in all cases where power or control to the relay is lost.

Further to that, the type of signal to the generator can be selected as N/O (Normally Open) or N/C (Normally Closed) by selecting the relevant output pins of the control relay.

Number of Generator Control Outputs: The ACU+ Hybrid software can control one or two generators. Each generator control is designated as DG1 or DG2 output. A User selectable menu will allow selecting DG1, DG2, or DG1 and DG2. When both are selected they will be alternatively used (two generator operation).

Diesel Fail Alarm: A diesel fail alarm will be generated if the Diesel Generator ON signal fails to bring the generator to operation and provide the system with AC power. Alarm will be triggered after 60 seconds (default value, settable) from ON signal. If two generator operations are selected simultaneously with the alarm, the second Diesel Generator ON signal will be activated.

Battery Fuse Trip Alarm: In the event of a Battery Fuse trip condition an alarm will be generated.

Under Voltage Alarms:

- **Under Voltage Alarm 1:** An Under Voltage Alarm 1 is set. If voltage decreases below this setting, an alarm is raised.
- **Under Voltage Alarm 2:** An Under Voltage Alarm 2 is set. If voltage decreases below this setting, the Diesel Generator is started and an alarm is raised.

LVD 1: Normal loads are disconnected.

LVD 2: Priority loads are disconnected.

Charge Voltage:

Refer to Figure 6.

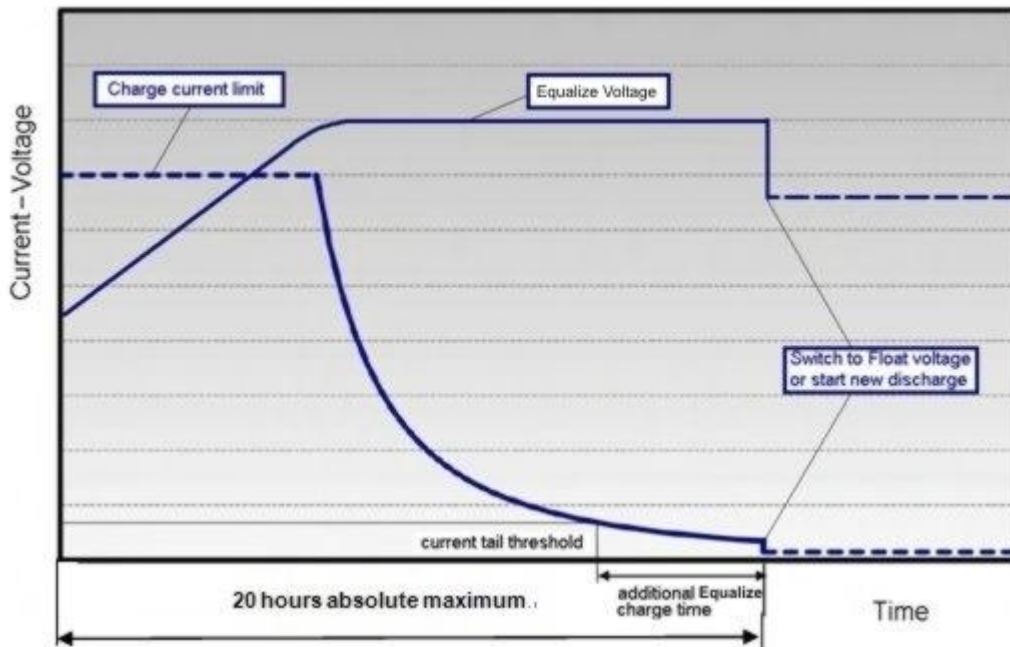

Figure 6
Charge Voltage

Equalize Charge: The battery will be recharged at equalize voltage. This is the voltage set in the initial phase of battery recharge. See Figure 6.

As the voltage limit is reached, the charge current is gradually reduced – effect known as current tail. When the current tail falls below a set of threshold levels, additional equalize charge time is added.

The equalize charge current tail threshold is settable from 0.01 to 0.05. Default setting is 0.02 (2A per 100Ah). The additional equalize charge time is settable from 0 hours to 7 hours (settable in minutes from 0 to 720), default setting is 4 hours. The duration of the equalize charge is determined as the time from the start of the recharge to the end of the additional time. (Maximum charge time, determined from the time charge starts, is settable in the range of 5-24h.)

The end of recharge is determined by a three (3) step approach:

Step1 - calculated battery capacity exceeds 90%. Calculation is performed by measurement of battery current and time, in Ah.

Step 2 - charge current tail threshold is reached.

Step 3 - additional charge time is added.

Float Charge: Default float voltage is 54.0V at 20°C with a temperature compensation of -72mV per °C.

If battery temperature exceeds 38°C, the charge voltage is reduced to 51V to reduce gassing and prevent thermal runaway. The same is applicable as well for equalizing charge.

Equalizing Charge: As the cyclic use does not ensure complete battery recharge after every cycle, an equalizing charge cycle is added. The equalizing cycle will occur up to four times a month, settable for every 7 to 60 days intervals. Start date and time is settable. Equalizing charge time is 20 hours independent of discharge time setting. Equalizing charge is performed at equalize voltage until end of additional equalize time and thereafter at float voltage for the remaining time. Also see Figure 6.

Equalize charge independently settable 0-720 min (already set in equalize charge).

Early Termination of the Discharge Periods

During discharge, over temperature and under voltage conditions will interrupt the discharge and change the operation to charge – Diesel Generator ON.

Over Temperature: The diesel generator will start and run for a period before it is stopped again. The run time is User selectable in the range 30 to 120 minutes, default setting is 60 minutes. Temperature is referenced to cabinet/shelter ambient temperature sensor connected to the Controller, not battery temperature. Over temperature start can be disabled completely from User settings menu.

Under Voltage: The under voltage start is triggered by under voltage alarm 2 voltage settings.

The diesel generator will start and run until the normal recharge cycle is due to finish depending on selected mode of operation.

Example for Fixed Daily Time: If the normal recharge cycle is from 7am until 7pm and under voltage has started the diesel generator at 5:30am, the effective recharge will be from 5:30am until 7pm.

Example for Capacity Discharge: If this mode is selected, the recharge will terminate.

Operation with Grid Power

Grid power is always prioritized when available. If grid power becomes available during battery discharge, the discharge cycle is terminated and recharge cycle is initiated. If grid power becomes available during diesel generator operation, the diesel generator is switched OFF and operations continue on grid power.

Battery Recharge with Grid Power: Battery recharge with grid power can start from the beginning (case of grid power becoming available during battery discharge) or can continue over from diesel generator recharge depending on the timing. In both cases, the recharge process will follow the recharge profile shown in Figure 6. If battery becomes fully recharged and grid power is still present, the operations will continue to be powered from grid and no battery discharge will be initiated for the duration of grid availability. In this case battery voltage will revert back to Float voltage.

Battery Discharge after Grid Failure: At the point of grid power failure, the battery capacity is unknown as these events occur in random manner. For the purpose of maximizing the use of grid power and in anticipation of grid power becoming available again, the Hybrid operation will continue with battery discharge cycle. Discharge will continue until:

- The preset discharge time elapses (Fixed Daily Time).
- The preset DOD is reached (Capacity Discharge).

In both cases, the discharge can be terminated earlier as described in “Early Termination of the Discharge Periods”.

Relay Assignment – when in Hybrid Mode

Relay 1: Generator Alarm

- No Generator Voltage Alarm. No AC supply, 60 sec delay.

Relay 2: Battery Alarms

- Logic alarm generated from: under voltage 1, under voltage 2, LVD1, LVD2, battery high temp, battery very high temp, overvoltage 1, overvoltage 2, battery temp sensor fail, battery fuse alarms, and high load alarm.

Relay 3: Rectifier Alarms

- Logic alarm generated from: multiple rectifier fail, rectifier fail, rectifier fan failure, rectifier HVSD, rectifier AC failure, and rectifier not responding.

Relay 4: System Alarms

- Logic alarm generated from: load fuse alarms, high ambient temperature, ambient temp sensor fail, smoke detected, and water detection.

Relay 5: Generator Run At High Temp

- Output to intelligent cooling devices linked to AC supply (DG run).

Relay 6: Intruder Alarm

- Alarm triggered by dry contact door/motion sensor.

Relay 7: Diesel 1 in Operation

- Output to DG1 on site. DG is set on for the duration of the signal.

Relay 8: Diesel 2 in Operation

- Output to DG2 on site. DG is set on for the duration of the signal.

Fixed Daily

In this mode of operation the total duration of a complete cycle is 24hr. Such duration is necessary as the operation is synchronized with day-night temperature pattern. When an extended recharge cycle is required, the termination of it will still follow the 24hr schedule.

Cycle Duration: A complete cycle consists of discharge and charge periods to the combined total of 24hrs. The discharge period starts at 7pm. It is then followed by recharge period (Diesel Generator ON) for the remaining of the 24hrs. The discharge time is User selectable in the range 1hrs to 22hrs, default setting is 12hrs.

Discharge: The discharge start time and duration are settable. Discharge period starts at 7pm. The discharge time is User selectable in the range 1hrs to 22hrs, default setting is 12hrs.

Recharge: Recharge period (Diesel Generator ON) follows after discharge for the remaining of the 24hrs. Recharge is performed at equalize voltage until added equalize time elapses and at float voltage for the remaining charge time.

High Load Alarm: In order to identify conditions where the load requirements are exceeding the dimensioning of the Hybrid site, an alarm must be generated. The alarm will be triggered upon exceeding the maximum capacity per discharge cycle. The threshold value will be set as default to 40% of battery capacity. It will require capacity measurement per cycle. The alarm will be set once the high load threshold value is reached and is reset at the beginning of the next discharge period. This alarm will also allow distinguishing the root cause of under voltage conditions: is it high load demand or is it a battery ageing and associated loss of capacity issue or insufficient charge capacity.

Capacity Discharge

The cycle period is determined by User selectable capacity discharge of the batteries and associated recharge times. After that the cycle repeats itself. It does not follow a 24hr pattern.

Capacity Discharge and Recharge: The battery discharge period is determined by the percentage of the nominal battery capacity [Ah] that will be discharged per cycle.

The depth of discharge [DOD] per cycle is User selectable in the range 20% to 80%. Default setting is 60%. The value is set as battery capacity at the end of each discharge period. Therefore, if a 60% discharge is chosen, the discharge value is set to 40%.

The time to recharge to full battery capacity depends on battery capacity at the start of the charge cycle and available recharge current.

When the additional charge time has been reached; the generator will be stopped, the recharge cycle will end, and discharge cycle will be initiated.

For practical purposes, the battery capacity at the end of every recharge period is set to 100% as long as Step 1, Step 2, and Step 3 have elapsed.

If end of charge is not reached within the set maximum hrs, the recharge will be terminated anyway and discharge cycle will be initiated.

1.3.12 Maximum Current Limit Function

The current available from the rectifiers can be programmed (in AMPS) from 10% to 121% of combined rectifier capacity. The factory setting is 121% unless otherwise specified. The current available from the converters can be programmed (in AMPS) from 50% to 116% of combined converter capacity. The factory setting is 116% unless otherwise specified. Refer to the ACU+ Configuration Drawing (C-drawing) supplied with your system documentation for your system's settings.

If a rectifier or converter is added, the respective current limit point will automatically increase by the percentage each existing rectifier or converter was set to provide prior to the addition.

If a rectifier or converter is removed from the system (and the Rect Comm Fail or Conv Comm Fail alarm is reset), the respective current limit point will remain unchanged unless the capacity of the remaining rectifiers or converters is not sufficient to maintain the present current limit point. If that happens, the current limit point will automatically increase to the maximum (121% of the remaining rectifiers or 116% of the remaining converters).

CHAPTER 2. OPERATION

2.1 Local Indicators

Location and Identification: Refer to Figure 7.

Description: There are three (3) indicators located on the ACU+ Controller's front panel. Refer to Table 2 for the function of the indicators.

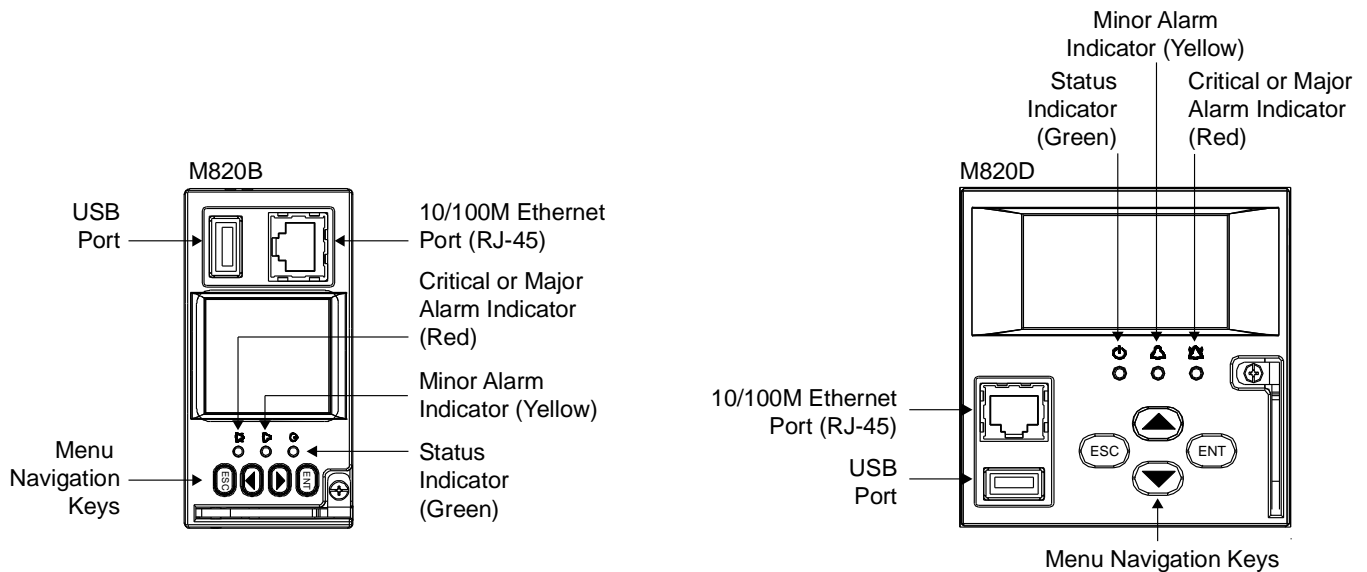

Figure 7
Local Indicators and Menu Navigation Keys Locations



Indicator		Normal State	Fault State	Fault Cause
	Status (Green)	On	Off	No input power to the ACU+ Controller.
	Minor Alarm (Yellow)	Off	On	The system has one or more active Minor alarms. Alarm conditions are programmable.
	Critical/Major Alarm (Red)	Off	On	The system has one or more active Critical or Major alarms. Alarm conditions are programmable.

Table 2
Local Indicators

2.2 Passwords and Access Levels

- Users (for local and Web access to the ACU+ Controller) are set via the Web Interface. Note that anyone can browse the ACU+ via the local keypad and display. A password is required to change settings. Web access always requires a User Name and password to be entered to gain access.
- Users are configured with a User Name, password, and access level.

User Name: Maximum 13 Characters (0-9, a-z, A-Z, _).

Password: Maximum 13 Characters (0-9, a-z, A-Z, _).

Once a password is entered, it remains in effect for a preset time period to allow navigating between menus without re-entering the password.

Access Level: Refer to the following table.

A User has access to his/her level menus, plus all menus of the lesser access levels.

Access Level (Authority Level)	Default User Name and Password	Authority
Level A (Browser)	none set	The User can only read (browse) information in the menus.
Level B (Operator)	none set	The User has access to the system "Control" menus.
Level C (Engineer)	none set	The User has access to the system "Setting" menus and can download the configuration file.
Level D (Administrator)	Admin, 1	The User has full access to all menus; including update the OS application and modifying, adding, and deleting Users.

2.3 Local Keypad and Display Access

2.3.1 Local Menu Navigation Keys and LCD Display

Location and Identification: Refer to Figure 7.

Description: There are four (4) menu navigation keys and an LCD display located on the ACU+ Controller's front panel. Refer to Table 3 for the function of the menu navigation keys.

Note: *When the LCD is lit, if no button is pushed for 8 minutes, the backlight of the LCD display extinguishes and the ACU+ Controller returns to the Main Screen. Press any key to re-activate the LCD display.*

Key Symbol	Key Name	Function	
ESC	Escape	Press this key to go back to a previous menu or to cancel setting a parameter.	Press ESC and ENT together to reset the ACU+ Controller, then press ENT to accept or ESC to cancel.
ENT	Enter	Press this key to go forward to the next menu, to select a parameter to edit, or to validate a parameter setting change.	
▲	Up	Press ▲ or ▼ to scroll through the menus or to change the value of a parameter.	--
▼	Down		

Press any key to silence an audible alarm.

Table 3
Local Menu Navigation Keys

2.3.2 Local Display Menus

Refer to "Chapter 3. Local Display Menus".

Note: *A valid password is required to access menus that allow changing any power system parameter.*

Navigating the Menus

To Select a Sub-Menu:

Press the up or down arrow keys to move the cursor up and down the list of sub-menus in the menu screen (selects the sub-menu), then press **ENT** to enter the selected sub-menu.

To Enter a Password:

If a password screen opens, a password must be entered to allow the User to make adjustments. To enter a password, with the cursor at the User Name field (default is "Admin"), press the down arrow key to move cursor down to the password line. Press **ENT**. "0" is highlighted. Press the up arrow key once to change the "0" to "1" (default password is "1"), then press **ENT** twice. (**Note:** *If you have been assigned a unique User Name and password, follow this procedure to enter these.*)

To Change a Parameter:

Press the up or down arrow keys to move the cursor up and down the list of parameters in the menu screen (selects the parameter to change), then press **ENT** to change the selected parameter. The parameter field highlights. Press the up or down arrow keys to change the parameter value. Press **ENT** to confirm the change.

2.4 WEB Interface Access

Note: The ACU+ supports a 10/100M Ethernet connection.

2.4.1 Overview

Via the WEB Interface, a User (with proper access level) can:

- View real-time operating information (rectifiers, converters, AC, DC, Batteries, etc.).
- View and download information recorded in logs.
- Send control commands.
- Set programmable parameters.
- Download and upload configuration files.
- Download firmware to the Controller.

2.4.2 Setting IP Communications Parameters

The Controller's IP parameters (IP, subnet mask, and gateway addresses) must be set to match your company's network settings. The default settings for these parameters are shown below.

- IP Address: 192.168.1.2
- Subnet Mask Address: 255.255.255.0
- Gateway Address: 192.168.1.1

Local Menu Navigation: Main Menu / Settings / Communication / enter parameters.

WEB Menu Navigation: Maintenance / Network Configuration / enter parameters.

2.4.3 WEB Interface Menus

Refer to "Chapter 4. WEB Interface Menus".

2.4.4 Connecting the Controller Locally (via the Ethernet Port)

Before connecting your computer directly to the Controller's Ethernet Port, record your current network settings as outlined below, then change these settings to match the communications settings programmed into the Controller.

Procedure

- 1) Record your computer's network settings by launching **Control Panel** in your computer. Navigate through **Network Connections** → **Local Area Connection** → **Properties** → **Internet Protocol (TCP/IP)** → **Properties**.
- 2) Record whether the "Obtain an IP address automatically" or "Use the following IP address" button is selected. If "Use the following IP address" button is selected, also record the following:

IP Address: _____
Subnet Mask: _____
Default Gateway: _____

- 3) Record your Controller's network settings by navigating the Controller's local display panel to **Main Menu** → **Settings** → **Communication**.
- 4) Record the following information:

IP Address: _____
Subnet Mask: _____
Default Gateway: _____
Example:
IP Address: 192.168.1.2

Subnet Mask: 255.255.255.0
Default Gateway: 192.168.1.1

- 5) Change your local computer's network settings using the information you acquired in Step 4), except that the last part of the IP address needs to be replaced with any different number.

IP Address: _____
Subnet Mask: _____
Default Gateway: _____

Example:
IP Address: 192.168.1.3
Subnet Mask: 255.255.255.0
Default Gateway: 192.168.1.1

- 6) Select **OK**. Note that you may have to reboot your local computer for the settings to take effect. Follow any instruction you see on the screen.

2.4.5 Disabling Proxy Server Settings to Enable a Connection to the Controller over an Intranet Network (if required)

Note: This procedure needs to be performed only when the Controller is connected to an Intranet and the User's computer is set to access the Intranet through a proxy server. Note that if the Controller is connected to the Internet and the User's computer is connected to an Intranet, the User may not be able to disable the proxy server and access the Controller.

If the Controller's Ethernet Port is connected to your company's Intranet Network and your computer is also connected to the Intranet Network but requires access via a proxy server, you must disable the proxy server settings to access the Controller. Follow the procedure below to disable the proxy server settings.

Procedure

- 1) Launch "Internet Explorer".
- 2) Select **Internet Options** from the **Tools** menu. The "Internet Options" window opens. In the "Internet Options" window, select the **Connections** Tab.

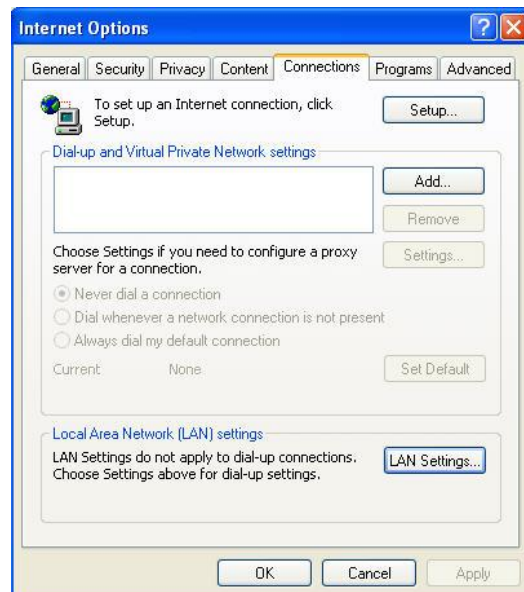

- 3) Click on the **LAN Settings...** button. The following window opens. In the LAN Settings window, uncheck the Proxy Server box and click **OK**.

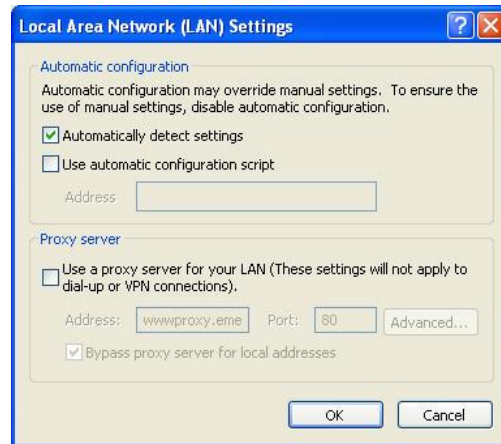

2.4.6 Logging into the Controller

Procedure

- 1) Internet Explorer, version 5.5 or newer, is required. It is best to view the WEB Interface at 1280 x 1024 resolution. In newer versions of Internet Explorer, you may need to turn Compatibility View On (Tools Menu / Compatibility View).
- 2) In Internet Explorer, enter the IP address programmed into the Controller and press **ENTER**. The following WEB Interface window opens. Enter a valid **User Name** and **Password** then click **LOGIN**.
Note: By default, the "User Name" is "admin" and the "Password" is "1".
- 3) After entering a valid **User Name** and **Password** and clicking **LOGIN**, the "HOMEPAGE" window opens. Refer to "Chapter 4. WEB Interface Menus".



2.5 Common Tasks Performed via the Local Keypad and/or Web Interface

Refer also to “Chapter 3. Local Display Menus” and “Chapter 4. WEB Interface Menus”.

2.5.1 Backing Up the Configuration

A file named “SettingParam.run” is automatically created/appended by the Controller whenever a User makes changes to any parameter settings via the LCD or WEB interface. This file can be saved to your computer so you can restore any custom settings you may have made.

Prior to changing settings, ensure the current “SettingParam.run” file is backed up. After making changes, create a new backup file. Note that you may change the name of a “SettingParam.run” file to differentiate it from other files saved. The new name can use alpha and numeric characters preceding the original “SettingParam.run” name (the end of the new file name **must** always be “SettingParam.run”; for example, an acceptable filename would be “seville4SettingParam.run”).

Local Menu Navigation: none.

WEB Menu Navigation: See also “4.7.9. Retrieve ‘SettingParam.run’ File Sub-Menu”.

- 1) Log onto the Controller using the WEB Interface.
- 2) Click on “Retrieve SettingParam.run” in the MAINTENANCE MENU.
- 3) Click on the “Retrieve File” button to save the file named “SettingParam.run” to your hard drive.

Note: Ensure Internet Explorer security settings are set to enable a file to be downloaded.

- 4) Select where you want the file to be copied to on your computer.

2.5.2 Reloading a Backed-Up Configuration

Reload the ACU+ configuration by restoring the “SettingParam.run” file previously saved. Refer to “2.5.1 Backing Up the Configuration” for a procedure to save the “SettingParam.run” file.

Local Menu Navigation: none.

WEB Menu Navigation: See also “4.7.8 Download Sub-Menu”.

- 1) Log onto the Controller using the WEB Interface.
- 2) Click on “Download” in the MAINTENANCE MENU.
- 3) The “Stop Controller” window opens. Click on the “Stop Controller” button.
- 4) A Download window opens.

Warning: *Never navigate from this web page without first clicking on “Start Controller”. If you do, you will not have web access. A manual system reset is required to restore web access.*

- 5) Click the “Browse....” button and navigate to the folder where the file is located. Select the file and then click the “Download” button. Click “Start Controller” to restart the Controller with the downloaded file installed.

2.5.3 Reloading the Configuration File Stored in the ACU+ Controller

Note: When this procedure is performed, the “SettingParam.run” file (see 2.5.1) is deleted.

Local Menu Navigation: Main Menu / Settings / Controller / Reload Config.

The only selection for “Reload Config” is Yes. Once Yes is selected and confirmed, the configuration file stored in the ACU+ Controller is reloaded into memory. All settings WILL BE restored to the factory defaults of the configuration file.

WEB Menu Navigation: Maintenance / Restore Factory Defaults / select “Restore Defaults”.

2.5.4 Downloading a Configuration or an Application ("All") Package into the ACU+ Controller

The name of the Configuration or Application "All" Package file must end in .tar or .tar.gz. An Application "All" package file has both the application (software) and configuration files and is usually supplied for an application upgrade.

Local Menu Navigation: A User can copy a Configuration or an Application ("All") Package from your computer to a USB memory device. You can then place the USB memory device into the ACU+ USB port and then download the file into the ACU+ Controller.

To Download a Configuration Locally:

- 1) Copy the file to a USB memory device. The file must be in the root directory of the USB memory device. The file must be named app_cfg.tar or app_cfg.tar.gz.
- 2) Connect the USB memory device to the USB port on the front of the Controller.
- 3) Navigate to Main Menu / Settings / Controller / Download Config.
- 4) The only selection for "Download Config" is Yes. Once Yes is selected and confirmed, the configuration file located on the memory device located in the Controller's USB port is loaded into the Controller.
- 5) After the file is downloaded, remove the memory device from the Controller's USB port.
- 6) Return to the Main Screen, then reboot the Controller (press ENT and ESC at the same time).
- 7) The screen displays "System Is Rebooting" then "App Exited".
- 8) The Controller enters an initialization routine, which takes a few minutes. The routine is complete and the Controller is operational when normal system voltage is displayed on the screen.

To Download an Application ("All") Package Locally:

- 1) Copy the file to a USB memory device. The file must be in the root directory of the USB memory device. The file must be named app.tar.gz.
- 2) Connect the USB memory device to the USB port on the front of the Controller.
- 3) With the Controller displaying the Main Screen, reboot the Controller (press ENT and ESC at the same time).
- 4) The screen displays "Acknowledge Info. Reboot System."
- 5) Press ENT to confirm.
- 6) The screen displays...
"System Is Rebooting"
"App Exited"
then the Emerson Network Power logo appears followed by...
"Press the key ENT to Download the Application."
- 7) Press ENT.
- 8) The screen displays "Please Wait".
- 9) The Controller enters an initialization routine, which takes a few minutes. The routine is complete and the Controller is operational when normal system voltage is displayed on the screen.
- 10) Remove the memory device.

WEB Menu Navigation: See also "4.7.8 Download Sub-Menu".

- 1) Log onto the Controller using the WEB Interface.
- 2) Click on "Download" in the MAINTENANCE MENU.

- 3) The "Stop Controller" window opens. Click on the "Stop Controller" button.
- 4) A Download window opens.

Warning: *Never navigate from this web page without first clicking on "Start Controller". If you do, you will not have web access. A manual system reset is required to restore web access.*

- 5) Click the "Browse..." button and navigate to the folder where the file is located. Select the file and then click the "Download" button. Click "Start Controller" to restart the Controller with the downloaded file installed.

2.5.5 Rebooting the Controller

Local Menu Navigation: Press ENT and ESC at the same time to reset the ACU+ Controller.

WEB Menu Navigation: Maintenance / Restore Factory Defaults / select "Reboot Controller".

2.5.6 Changing the Local LCD Display Contrast

Local Menu Navigation: Press ENT and UP ARROW or ENT and DOWN ARROW while in the Main Screen to change the contrast of the LCD display.

WEB Menu Navigation: none.

2.5.7 Disabling the Local Keypad Sound

Local Menu Navigation: Main Menu / Settings / Controller / Keypad Voice.

To disable the keypad sound, set "Keypad Voice" to "Off".

WEB Menu Navigation: none.

2.5.8 Changing the Date

Local Menu Navigation: Main Menu / Settings / Controller / Date.

After selecting Date (by pressing **ENT** when the cursor is in the Date field), use ▲ and ▼ to select the year then press **ENT**, next use ▲ and ▼ to select the month then press **ENT**, and finally use ▲ and ▼ to select the day then press **ENT**.

WEB Menu Navigation: Maintenance / Time Sync.

2.5.9 Changing the Time

Local Menu Navigation: Main Menu / Settings / Controller / Time.

After selecting Time (by pressing **ENT** when the cursor is in the Time field), use ▲ and ▼ to select the hour then press **ENT**, next use ▲ and ▼ to select the minute then press **ENT**, and finally use ▲ and ▼ to select the second then press **ENT**.

WEB Menu Navigation: Maintenance / Time Sync.

2.5.10 Adding, Deleting, and Modifying Users

Local Menu Navigation: none.

WEB Menu Navigation: Refer to "4.7.5 User Information Settings Sub-Menu".

2.5.11 Assigning Severity Level to Alarms

Local Menu Navigation: Main Menu / Settings / Alarm Setting / Alm Severity.

WEB Menu Navigation: Configuration / Signal Information Modification / select entry from "Query Device Type" list / select "Alarm Signal" from "Signal Type" list / select entry from "New Level" list / press "Set".

2.5.12 Assigning Relays to Alarms

Local Menu Navigation: Main Menu / Settings / Alarm Setting / Alarm Relay.

WEB Menu Navigation: Configuration / Alarm Relays / select entry from “Standard Equipment” list / select entry from “New Relay Number” list / press “Modify”.

2.5.13 Changing the Names of Items Displayed in the LCD and Web-Interface Menus

Note: Only relay names and digital input names are recommended to be changed for troubleshooting purposes.

Local Menu Navigation: none.

WEB Menu Navigation: Configuration / Equipment Information Modification.
Configuration / Signal Information Modification.

2.5.14 Viewing Alarms

Local Menu Navigation: Main Menu / Status / Active Alarms.

WEB Menu Navigation: Active alarms are listed in the lower right window pane. If the window pane is collapsed, click the "arrow" icon  to expand the alarm list.

2.5.15 Clearing Rectifier Lost, Rectifier Communication Fail, Converter Lost, Converter Communication Fail, and All Converter Comm Fail Alarms

Navigate to the menus to clear the respective alarm as indicated below.

Local Menu Navigation: Main Menu / Manual / Rectifier / All Rect Ctrl.
Main Menu / Manual / Converter / All Conv Ctrl.

WEB Menu Navigation: Device Information / Rectifier Group / Control Tab.
Device Information / Converter Group / Control Tab.

2.5.16 Clearing SMTemp Lost and SMTemp Probe Alarms

Navigate to the menus to clear the respective alarm as indicated below.

Local Menu Navigation: Main Menu / Manual / SMTemp / SMTemp Group.
Main Menu / Manual / SMTemp / SMTemp #.

WEB Menu Navigation: Device Information / SM Temp Group / Control Tab.
Device Information / SM Temp Group / SM Temp # / Control Tab.

2.5.17 Clearing Battery Alarms

Navigate to the menus to clear the respective alarm as indicated below.

Local Menu Navigation: Main Menu / Manual / Batt Group.

WEB Menu Navigation: Device Information / Battery Group / Control Tab.

2.5.18 Clearing Logs

Local Menu Navigation: Main Menu / Settings / Alarm Setting / Alarm Param / Clr Alm Hist.

The only selection for "Clr Alm Hist" is Yes. Once Yes is selected and confirmed, the alarm history log is cleared.

WEB Menu Navigation: Maintenance / Clear Data.

Select which log to clear (“Alarm History”, “Data History”, “Control Command Log”, “Battery Test Log”, “System Runtime Log”, or “Diesel Test Log”). Select “Clear”.

2.5.19 Clearing the Maintenance Alarm

A maintenance time can be set which, once expires, issues a maintenance alarm. When the maintenance alarm is issued, perform the routine maintenance and reset the maintenance timer. To reset the maintenance timer and clear the Maintenance Alarm, clear the Maintenance Run Time.

Local Menu Navigation: Place Controller in Manual Mode, then Main Menu / Manual / Power System / Clr MtncRunTime.

The only selection for "Clr MtncRunTime" is Yes. Once Yes is selected and confirmed, the maintenance timer is reset and the maintenance alarm is cleared.

Place Controller back to Auto mode.

WEB Menu Navigation: Quick Settings / "Auto/Manual" Setting / change to Manual.
then
Device Information / Power System / select the Control Tab and
clear the maintenance timer.
then
Quick Settings / "Auto/Manual" Setting / change to Auto.

2.5.20 Viewing the ACU+ Controller's Device Inventory

Local Menu Navigation: Main Menu / Status / Sys Inventory.

WEB Menu Navigation: Maintenance / System Inventory.

2.5.21 Updating the ACU+ Controller's Device Inventory

Local Menu Navigation: Main Menu / Settings / Controller / Auto Config.

The only selection for "Auto Config" is Yes. Once Yes is selected and confirmed, the ACU+ Controller will auto-configure for the devices connected to it.

WEB Menu Navigation: Configuration / Auto Configuration.

2.5.22 Programming the Audible Alarm Feature

Local Menu Navigation: Main Menu / Settings / Alarm Setting / Alarm Param / Alarm Voice.

Set "Alarm Voice" to:

- **On:** When a new alarm occurs, the audible alarm sounds. Press any key to silence the audible alarm.
- **Off:** Disables the audible alarm.
- **3 minutes / 10 minutes / 1 hour / 4 hours:** When a new alarm occurs, the audible alarm sounds. The audible alarm automatically silences after the selected time period.

WEB Menu Navigation: none.

2.5.23 Blocking Alarms

Local Menu Navigation: Main Menu / Settings / Alarm Setting / Alarm Param / Block Alarm.
or

Local Menu Navigation: Main Menu / Settings / Power System / General / Alarm Blocked.

WEB Menu Navigation: Device Information / Power System / Settings Tab / Outgoing Alarms Blocked.

Set to:

- **Normal:** Alarms are processed normally.
- **Blocked:** Forces the alarm relays in the "off" state and blocks alarms from changing the relay state.

2.5.24 Configuring the ACU+ Identification of Rectifiers and Assigning which Input Phase is Connected to the Rectifiers

When rectifiers are all installed prior to applying power and starting the system, the order in which the ACU+ identifies the rectifiers is by serial number (lowest serial number is Rect 1, next lowest is Rect 2, etc.). If you prefer the ACU+ to identify the rectifiers by position in the system, perform the following procedure.

Upon power up, the ACU+ arbitrarily assigns Phase A, B, or C to each rectifier. This assignment is used to display rectifier AC input phase voltage(s). The User may reassign the phase to each rectifier per your specific installation by following the procedure below.

Local Menu Navigation: Main Menu / Settings / Rectifier / Rect #1 / Rectifier ID and Rect Phase.
(repeat for every rectifier)
then
Main Menu / Manual / Rectifier / All Rect Ctrl / Confirm ID/PH.

WEB Menu Navigation: Device Information / Rectifier Group / Rectifier #1 / Settings Tab / Rectifier ID and Rectifier Phase.
(repeat for every rectifier)
then
Device Information / Rectifier Group / Control Tab / Confirm Rectifier "ID/Phase".

Local Procedure

- 1) With the Main screen displayed, press **ENT** to go to the Main Menu. Navigate to and select "**Settings**" (ENT).
- 2) If a password screen opens, a password must be entered to allow the User to make adjustments. If a password was previously entered and has not yet timed out, skip this step and proceed to step 3). Otherwise, to enter a password, with the cursor at the User Name field (default is "Admin"), press the down arrow key to move cursor down to the password line. Press **ENT**. "0" is highlighted. Press the up arrow key once to change the "0" to "1" (default password is "1"), then press **ENT** twice. (*Note: If you have been assigned a unique User Name and password, follow this procedure to enter these.*)
- 3) With the Settings menu screen displayed, navigate to and select "**Rectifier**" (ENT).
- 4) Navigate to "**Rect #**" (# is used here to represent the rectifier identification number). Press **ENT**. The rectifier # menu screen is displayed, and the green LED on one rectifier starts flashing. This is the rectifier currently identified by the ACU+ as rectifier #. (If this is not the rectifier you want, press **ESC** to return to rectifier menu screen and select a different rectifier.)
- 5) If you wish to change the Rectifier IDs, navigate to and select "**Rectifier ID**". Press **ENT**. Use the up or down keys to change the ACU+ identification number for the flashing rectifier. Press **ENT**.
- 6) If you wish to change the Rectifier Phase Assignment, navigate to and select "**Rect Phase**". Press **ENT**. Use the up or down keys to change the phase connected to the flashing rectifier. Press **ENT**.
- 7) Press **ESC** to return to rectifier menu screen.
- 8) Navigate to and select the next rectifier.
- 9) Repeat steps 4) through 8) for each of the remaining rectifiers in the system.
- 10) When you have finished selecting identification numbers and phases for all rectifiers, repeatedly press **ESC** to return to the Main Menu.
- 11) Navigate to and select "**Manual**" (ENT) / "**Rectifier**" (ENT) / "**All Rect Ctrl**" (ENT).
- 12) Navigate to "**Confirm ID/PH**". Press **ENT**. "Yes" highlights.

13) Press **ENT** to select the operation. Press **ENT** again to confirm.

Note: Check you numbering to be sure it is correct. If there were conflicts in your numbering, rectifiers with conflicts will be assigned the next available sequential number.

14) Return to the Main screen by repeatedly pressing **ESC** (escape).

2.5.25 Configuring the ACU+ Identification of Converters

When converters are all installed prior to applying power and starting the system, the order in which the ACU+ identifies the converters is by serial number (lowest serial number is Conv 1, next lowest is Conv 2, etc.).

If you prefer the ACU+ to identify the converters by position in the system, perform the following procedure.

Local Menu Navigation: Main Menu / Settings / Converter / Conv #1 / Set Conv ID.
(repeat for every converter)
then
Main Menu / Manual / Converter / All Conv Ctrl / Confirm ID.

WEB Menu Navigation: Device Information / Converter Group / Converter #1 / Settings Tab / Set Converter ID.
(repeat for every converter)
then
Device Information / Converter Group / Control Tab / Confirm Converters ID.

Local Procedure

- 1) With the Main screen displayed, press **ENT** to go to the Main Menu. Navigate to and select **"Settings"** (ENT).
- 2) If a password screen opens, a password must be entered to allow the User to make adjustments. If a password was previously entered and has not yet timed out, skip this step and proceed to step 3). Otherwise, to enter a password, with the cursor at the User Name field (default is "Admin"), press the down arrow key to move cursor down to the password line. Press **ENT**. "0" is highlighted. Press the up arrow key once to change the "0" to "1" (default password is "1"), then press **ENT** twice. (**Note:** If you have been assigned a unique User Name and password, follow this procedure to enter these.)
- 3) With the Settings menu screen displayed, navigate to and select **"Converter"** (ENT).
- 4) Navigate to **"Conv #"** (# is used here to represent the converter identification number). Press **ENT**. The converter # menu screen is displayed, and the green LED on one converter starts flashing. This is the converter currently identified by the ACU+ as converter #. (If this is not the converter you want, press **ESC** to return to converter menu screen and select a different converter.)
- 5) Navigate to and select **"Set Conv ID"**. Press **ENT**. Use the up or down keys to change the ACU+ identification number for the flashing converter. Press **ENT**.
- 6) Press **ESC** to return to converter menu screen.
- 7) Navigate to and select the next converter.
- 8) Repeat steps 4) through 7) for each of the remaining converters in the system.
- 9) When you have finished selecting identification numbers for all converters, repeatedly press **ESC** to return to the Main Menu.
- 10) Navigate to and select **"Manual"** (ENT) / **"Converter"** (ENT) / **"All Conv Ctrl"** (ENT).
- 11) Navigate to **"Confirm ID"**. Press **ENT**. **"Yes"** highlights.
- 12) Press **ENT** to select the operation. Press **ENT** again to confirm.

Note: Check you numbering to be sure it is correct. If there where conflicts in your numbering, converters with conflicts will be assigned the next available sequential number.

13) Return to the Main screen by repeatedly pressing **ESC** (escape).

2.5.26 Viewing/Changing the Float Voltage Setting

Local Menu Navigation: Main Menu / Settings / Battery / Charge / Float Voltage.

Local Menu Navigation: Main Menu / Quick Setting / "FLT/EQ" Voltag / Float Voltage.

WEB Menu Navigation: Device Information / Battery Group / Settings Tab / Float Charge Voltage.

WEB Menu Navigation: Quick Settings / "Float/Equalize" Charge Voltage.

2.5.27 Viewing/Changing the Equalize Voltage Setting

Local Menu Navigation: Main Menu / Settings / Battery / Charge / EQ Voltage.

Local Menu Navigation: Main Menu / Quick Setting / "FLT/EQ" Voltag / EQ Voltage.

WEB Menu Navigation: Device Information / Battery Group / Settings Tab / Equalize Charge Voltage.

WEB Menu Navigation: Quick Settings / "Float/Equalize" Charge Voltage.

2.5.28 Setting Digital Inputs

Local Menu Navigation: Main Menu / Settings / Power System / General / DI[number] Alarm State.

WEB Menu Navigation: Device Information / Power System / Settings Tab / DI[number] Alarm State.

2.5.29 Setting Temperature Sensors

Temperature sensors may be connected to the...

- Temp1 and Temp2 ports on an IB2 Interface Board,
- Temp1 and Temp2 ports on an EIB Interface Board, and
- Temp1 through Temp8 ports of up to eight (8) SM-Temp modules.

Each port (sensor) may be set as None, Battery, or Ambient.

A temperature sensor set as an ambient temperature sensor may also be set as the sensor which displays the ambient temperature on the Web Interface's Homepage.

A temperature sensor set as a battery temperature sensor may also be set as the temperature compensation sensor (in addition, the temperature compensation sensor is the sensor which displays the battery temperature on the Web Interface's Homepage).

A temperature sensor set as a battery temperature sensor may also be set as the BTRM (Battery Thermal Runaway Management) sensor (in addition, the BTRM sensor is the sensor which is used for the High Temperature Disconnect [HTD] Feature.)

- First, set each temperature sensor in the system to None, Battery, or Ambient.

Local Menu Navigation: Main Menu / Settings / Power System / General / IB2 Temp#.
Main Menu / Settings / Power System / General / EIB Temp#.
Main Menu / Settings / SMTemp / SMTemp # / T# Assign Equip.

WEB Menu Navigation: Device Information / Power System / Settings Tab / IB2 Temp #.
Device Information / Power System / Settings Tab / EIB Temp #.
Device Information / SM Temp Group / SM Temp # / Settings Tab /
Temperature# Assign Equipment.

Note: Also set High2, High1, and Low temperature alarms for each temperature sensor (from the Web Interface). Note that you cannot set high and low temperature alarms for individual temperature sensors from the Local Menus. High and low temperature alarm settings for the temperature sensors set as ambient are found in the Device Information / Power System / Settings tab. High and low temperature alarm settings for the probes set as battery are found in the Device Information / Battery Group / Settings tab.

- Second, if desired, set a temperature sensor set as an ambient temperature sensor as the sensor which displays the ambient temperature on the Web Interface's Homepage. Then set High2, High1, and Low ambient temperature alarms (from the same menu).

Local Menu Navigation: Main Menu / Settings / Power System / Amb Temp Sensor.

WEB Menu Navigation: Device Information / Power System / Settings Tab / Ambient Temp Sensor.

- Third, if desired, set a temperature sensor set as a battery temperature sensor as the battery temperature compensation sensor. Then set High2, High1, and Low compensation temperature alarms (from the same menu).

Local Menu Navigation: Main Menu / Settings / Battery / Temp Comp / TempComp Sensor.

WEB Menu Navigation: Device Information / Battery Group / Settings Tab / Temp Compensation Probe Number.

- Fourth, if desired, set a temperature sensor set as a battery temperature sensor as the BTRM sensor. Then set High2 and High1 BTRM temperature alarms (from the same menu). If battery temperature exceeds the "BTRM Temp High2" setting, system voltage is lowered to the BTRM voltage setting (set from the same menu). Note, you must first enable this feature (from the same menu).

Local Menu Navigation: Main Menu / Settings / Battery / Basic / BTRM TempSensor.

WEB Menu Navigation: Device Information / Battery Group / Settings Tab / BTRM Temp Sensor.

2.5.30 Setting Battery Charge Temperature Compensation

The following need to be set for the Battery Charge Temperature Compensation feature.

See above for selecting the battery temperature compensation temperature sensor; or select maximum, average, or Average SMBRC.

- **Local Menu Navigation:** Main Menu / Settings / Battery / Temp Comp.
Enter values for the following parameters: Temp CompCenter, Temp Comp Coeff, TempComp Sensor, Comp Temp High2, Comp Temp High1, Comp Temp Low, Temp Comp Max V, Temp Comp Clamp, and Temp Comp Min V (note that you have to enable Temp Comp Clamp to set the Temp Comp Max V and Min V values).

WEB Menu Navigation: Quick Settings / Temp Compensation Setting.

Enter values for the following parameters: Temperature Compensation Center, Temp Comp Coefficient (slope), Temp Compensation Probe Number, Comp Temp High2, Comp Temp High1, Comp Temp Low, Temp Comp Voltage Clamp, Temp Comp Max Voltage, and Temp Comp Min Voltage (note that you have to enable Temp Comp Clamp to set the Temp Comp Max V and Min V values).

2.5.31 Setting Auto Equalize

Local Menu Navigation: Main Menu / Settings / Battery / Charge / Auto EQ / once enabled, additional parameters appear.

Local Menu Navigation: Main Menu / Settings / Battery / Charge / Cyc EQ / once enabled, additional parameters appear.

Local Menu Navigation: Main Menu / Quick Setting / "FLT/EQ" Set.

Also set “Maximum EQ Time” in same menu.

WEB Menu Navigation: Device Information / Battery Group / Settings Tab / Automatic Equalize.
Once Automatic Equalize is enabled, additional parameters appear.

WEB Menu Navigation: Device Information / Battery Group / Settings Tab / Cyclic Equalize.
Once Cyclic Equalize is enabled, additional parameters appear.

WEB Menu Navigation: Quick Settings / “Float/Equalize” Settings / once Automatic Equalize and/or Cyclic Equalize is enabled, additional parameters appear.

Also set “Maximum Equalize Charge Time” in same menu.

2.5.32 Setting Battery Parameters

Local Menu Navigation: Main Menu / Settings / Battery / Battery # / enter parameters.

WEB Menu Navigation: Device Information / Battery Group / Battery # / select the Settings Tab and enter parameters.

2.5.33 Setting Battery Capacity Parameters

Local Menu Navigation: Main Menu / Settings / Battery / Battery # / Rated Capacity.

WEB Menu Navigation: Device Information / Battery Group / Battery # / select the Settings Tab and enter the Battery Rating parameter.

2.5.34 Setting Battery Block and Battery Midpoint Monitoring (if equipped with an EIB Assembly)

Local Menu Navigation: Main Menu / Settings / EIB / EIB 1 / enter the following parameters.

WEB Menu Navigation: Device Information / EIB Group / EIB 1 / select the Settings Tab and enter the following parameters.

Parameters

- Voltage Type
- Blk V Diff(12V) or Blk V Diff(Mid)
- Block In-Use

2.5.35 Setting IP Communications Parameters

Local Menu Navigation: Main Menu / Settings / Communication / enter parameters.

WEB Menu Navigation: Maintenance / Network Configuration / enter parameters.

2.5.36 Setting External Shunts (connected to the EIB Assembly)

Local Menu Navigation: Main Menu / Settings / EIB / EIB1 / enter the following parameters.

WEB Menu Navigation: Device Information / EIB Group / EIB 1 / select the Settings Tab and enter the following parameters.

Parameters

- Shunt # Current
- Shunt # Voltage
- Num Batt Shunts
- Num Load Shunts

2.5.37 Setting External Shunts (connected to the SM-DU+ Assembly)

Local Menu Navigation: none.

WEB Menu Navigation: Device Information / SMDUP Group / SMDUP 1 / select the Settings Tab and enter the following parameters.

Parameters

- Current1 Break Value (A) (Device rating.)
- Current1 High Current Limit (% of Current# Break Value.)
- Current1 Very High Current Limit (% of Current# Break Value.)
- Shunt # Current (Rating of Shunt.)
- Shunt # Voltage (Rating of Shunt.)

2.5.38 Setting the Load Current Alarm

Local Menu Navigation: Main Menu / Settings / Power System / General / Load Curr Alarm.

WEB Menu Navigation: Device Information / Power System / Settings Tab / Load Current Alarm.

Enter a value (in AMPS). If load current exceeds this value, a load current alarm is issued.

2.5.39 Placing the System in Float or Equalize Charge Mode

Local Menu Navigation: Main Menu / Manual / Batt Group / "EQ/FLT Control".

WEB Menu Navigation: Device Information / Battery Group / Control Tab / "Equalize/Float" Charge Control.

2.5.40 Manually Forcing Relays

See also "2.5.42 Using the Relay Test Feature".

Place Controller in Manual Mode, then...

Local Menu Navigation: Main Menu / Manual / Power System / Relay Output [number].
Main Menu / Manual / EIB / EIB1 / Relay Output [number].

- Select the other state for an alarm relay (active / not active).
- After confirming the change, the alarm relay will momentarily toggle to the chosen state. The alarm relay then reverts back to being controlled by the ACU+.

WEB Menu Navigation: Device Information / Power System / Control Tab.
Device Information / EIB Group / EIB1 / Control Tab.

The Control Tab allows you to change the state of an alarm relay.

- In the "Set value" box, select the other state for an alarm relay (active / not active).
- Click on "set".
- After confirming the change, the alarm relay will momentarily toggle to the chosen state. The alarm relay then reverts back to being controlled by the ACU+.

2.5.41 Manually Forcing LVDs

Place Controller in Manual Mode, then...

Local Menu Navigation: Main Menu / Manual / LVD / LVD Unit.

- Select the other state for an LVD (connected/disconnected).
- After confirming the change, the LVD will momentarily toggle to the chosen state. The LVD then reverts back to being controlled by the ACU+.

WEB Menu Navigation: Device Information / LVD Group / LVD Unit / select the Control Tab.

The Control Tab allows you to change the state of an LVD.

- In the "Set value" box, select the other state for an LVD (connected/disconnected).
- Click on "set".

- After confirming the change, the LVD will momentarily toggle to the chosen state. The LVD then reverts back to being controlled by the ACU+.

2.5.42 Using the Relay Test Feature

Note: *The relay test can only be performed when no alarms are present.*

Automatic Test

When placed in Relay Automatic Test Mode, all relays on the IB2 board deenergize (when set for Fail Safe), then one-by-one each relay energizes for the time period selected and then deenergizes. If the system is equipped with an EIB board, after the IB2 relays are tested, one-by-one each relay on the EIB board deenergizes for the time period selected and then re-energizes. At the end of the test, all relays are returned to their normal state (if no alarms are present).

Local Menu Navigation: Main Menu / Settings / Power System / General / set the Relay Test Time.
then
Main Menu / Settings / Power System / General / Relay Test / set to Automatic.

Note: *The relay test can be exited at any time by setting the Relay Test to Disabled.*

WEB Menu Navigation: Device Information / Power System / Settings Tab / set the Relay Test Time.
then
Device Information / Power System / Settings Tab / Relay Test /
set to Automatic.

Note: *The relay test can be exited at any time by setting the Relay Test to Disabled.*

Individual Test

When placed in Relay Individual Test Mode, relays can be tested individually. This is the same procedure as “2.5.40 Manually Forcing Relays” except you do not place the Controller in Manual Mode.

Local Menu Navigation: Main Menu / Settings / Power System / General / Relay Test / set to Individual.
then
Main Menu / Manual / Power System / Relay Output [number]
(individually you can set the state of the relays on the IB2 Board).
Main Menu / Manual / EIB / EIB1 / Relay Output [number]
(individually you can set the state of the relays on the EIB Board).

- Select the other state for an alarm relay (active / not active).
- After confirming the change, the alarm relay will momentarily toggle to the chosen state. The alarm relay then reverts back to being controlled by the ACU+.
- When done, set “Relay Test” to “Disabled”. Note that if there is no User interaction for 10 minutes, the Relay Test will automatically revert to the “disabled” state.

WEB Menu Navigation: Device Information / Power System / Settings Tab / Relay Test /
set to Individual.
then
Device Information / Power System / Control Tab.
(individually you can set the state of the relays on the IB2 Board).
Device Information / EIB Group / EIB 1 / Control Tab
(individually you can set the state of the relays on the EIB Board).

The Control Tab allows you to change the state of an alarm relay.

- In the "Set value" box, select the other state for an alarm relay (active / not active).
- Click on "set".
- After confirming the change, the alarm relay will momentarily toggle to the chosen state. The alarm relay then reverts back to being controlled by the ACU+.

- When done, set “Relay Test” to “Disabled”.

2.5.43 Spec. No. 588820300 Battery Rack System (Lithium Ion Battery Configuration)

When the ACU+ is equipped with the Lithium Ion Battery Configuration for use with Spec. No. 588820300 NetSure™ Battery Rack System, the only required settings for battery functions is the float voltage and ABCL (Active Battery Charge Current Limit) point.

Note: *The maximum value that the ABCL point can be adjusted to is 60A, which is below the maximum current the battery can handle.*

The batteries communicate their status and alarms to the ACU+. The ACU+ displays these via the LCD and WEB interfaces.

Batteries are added to the ACU+ inventory as they are detected. If a battery communications cable is removed, a Li-Ion Battery Communication Fail alarm is generated. If the controller resets while a Li-Ion Battery Communication Fail alarm is active, the alarm changes to a Li-Ion Battery Lost alarm. If you clear any of these alarms, that battery is removed from the ACU+ inventory.

2.6 Available Alarms

Table 4 lists the alarms that you can scroll through in the Alarm Severity and Alarm Relay submenus. These are also the possible alarms that display in the Active Alarms sub-menu. Table 4 also provides guidelines for alarm correction.

Note: *These instructions describe the complete functionality of the ACU+. Some functionality is dependent on hardware connected to the ACU+. Some alarms listed may not display in your system or may be named differently. Refer to the ACU+ Configuration Drawing (C-drawing) furnished with your system.*

Table 4

Full Alarm Name - WEB (Abbreviated Alarm Name - LCD)	Alarm Description	Action to Correct
Power System Alarms (Power System)		
Supervision Unit Fault (SelfDetect Fail)	Controller self detection test fails.	Replace the Controller.
CAN Communication Failure (CAN Comm Fail)	CAN bus communications failure.	Check communications cables.
Outgoing Alarms Blocked (Alarm Blocked)	Alarm relays are forced in the "off" state and alarms are blocked from changing the relay state.	Verify why Controller setting was changed before changing back.
Maintenance Time Limit Alarm (MtnC Time Alarm)	Controller issues a maintenance alarm.	Perform routine maintenance and reset maintenance timer.
"Config Error (Backup Config)" (Config Error 1)	Configuration error 1.	Reload configuration file.
"Config Error (Default Config)" (Config Error 2)	Configuration error 2.	
Imbalance System Current (Imbalance Curr)	Current sharing imbalance.	Check to see why current sharing is imbalanced.
Over Load (Over Load)	Output overload condition.	Check to see why output is overloaded.
SPD (SPD)	Surge protection device needs attention.	Check surge protection device.
EStop/EShutdown (EStop/EShutdown)	System in emergency stop or emergency shutdown mode.	Check to see why the system was placed in this mode.

Table 4

Full Alarm Name - WEB (Abbreviated Alarm Name - LCD)	Alarm Description	Action to Correct
System Temp1 Not Used (System T1 Not U)	Temperature sensor port #1 is not used.	(Note: This alarm is not used at this time.)
System Temp2 Not Used (System T2 Not U)	Temperature sensor port #2 is not used.	
System Temp3 Not Used (System T3 Not U)	Temperature sensor port #3 is not used.	
IB2 Temp1 Not Used (IB2 T1 Not Used)	Temperature sensor port #1 (on IB2 Board) is empty.	--
IB2 Temp2 Not Used (IB2 T2 Not Used)	Temperature sensor port #2 (on IB2 Board) is empty.	
EIB Temp1 Not Used (EIB T1 Not Used)	Temperature sensor port #1 (on EIB Board) is empty.	--
EIB Temp2 Not Used (EIB T2 Not Used)	Temperature sensor port #2 (on EIB Board) is empty.	
System Temp1 Sensor Fault (System T1 Senso)	Temperature sensor #1 failure.	(Note: This alarm is not used at this time.)
System Temp2 Sensor Fault (System T2 Senso)	Temperature sensor #2 failure.	
System Temp3 Sensor Fault (System T3 Senso)	Temperature sensor #3 failure.	
IB2 Temp1 Sensor Fault (IB2 T1 Sensor F)	Temperature sensor #1 (connected to IB2 Board) failure.	Replace temperature sensor.
IB2 Temp2 Sensor Fault (IB2 T2 Sensor F)	Temperature sensor #2 (connected to IB2 Board) failure.	
EIB Temp1 Sensor Fault (EIB T1 Sensor F)	Temperature sensor #1 (connected to EIB Board) failure.	Replace temperature sensor.
EIB Temp2 Sensor Fault (EIB T2 Sensor F)	Temperature sensor #2 (connected to EIB Board) failure.	
DHCP Failure (DHCP Failure)	The DHCP function is enabled, but effective IP address cannot be acquired.	Verify DHCP IP address.
PLC Config Error (PLC Config Err)	PLC configuration error.	Re-enter the PLC logic functions.

Table 4

Full Alarm Name - WEB (Abbreviated Alarm Name - LCD)	Alarm Description	Action to Correct
485 Communication Failure (485 Comm Fail)	485 communications failure.	--
Minor Summary (MN Summary)	Minor alarm summary (one or more alarms designated as minor is active).	Check additional alarms.
Major Summary (MJ Summary)	Major alarm summary (one or more alarms designated as major is active).	Check additional alarms.
Critical Summary (CR Summary)	Critical alarm summary (one or more alarms designated as critical is active).	Check additional alarms.
Rectifier Group Lost (Rect Group Lost)	A rectifier group cannot be detected by the Controller.	Check communications cables. Check additional alarms.
Over Voltage 1 (Over Voltage 1)	Output voltage is higher than the Over Voltage 1 Alarm threshold.	Check to see why system voltage is high. Check the alarm setting.
Over Voltage 2 (Over Voltage 2)	Output voltage is higher than the Over Voltage 2 Alarm threshold.	
Under Voltage 1 (Under Voltage 1)	Output voltage is lower than the Under Voltage 1 Alarm threshold.	Check to see why system voltage is low. If there is a mains failure, check if some load could be switched off in order to prolong the operating time of the plant. If the system load is too high related to rectifier capacity, install additional rectifiers. If the batteries are being recharged, the alarm will cease by itself when battery voltage has increased to the charging level.
Under Voltage 2 (Under Voltage 2)	Output voltage is lower than the Under Voltage 2 Alarm threshold.	
Over Voltage 1 (24V) (24V Over Volt1)	Output voltage is higher than the Over Voltage 1 Alarm threshold.	Check to see why system voltage is high. Check the alarm setting.
Over Voltage 2 (24V) (24V Over Volt2)	Output voltage is higher than the Over Voltage 2 Alarm threshold.	

Table 4

Full Alarm Name - WEB (Abbreviated Alarm Name - LCD)	Alarm Description	Action to Correct
Under Voltage 1 (24V) (24V Under Volt1)	Output voltage is lower than the Under Voltage 1 Alarm threshold.	Check to see why system voltage is low. If there is a mains failure, check if some load could be switched off in order to prolong the operating time of the plant. If the system load is too high related to rectifier capacity, install additional rectifiers. If the batteries are being recharged, the alarm will cease by itself when battery voltage has increased to the charging level.
Under Voltage 2 (24V) (24V Under Volt2)	Output voltage is lower than the Under Voltage 2 Alarm threshold.	
Diesel Run Over Temp (DG Run OverTemp)	Diesel generator run over temperature alarm.	Check diesel generator.
DG1 is Running (DG1 is Running)	Diesel generator 1 is running.	--
DG2 is Running (DG2 is Running)	Diesel generator 2 is running.	--
Hybrid is High Load (High Load)	Diesel generator high load alarm.	Check load on diesel generator.
DG1 Failure (DG1 Failure)	Diesel generator 1 has failed.	Check diesel generator.
DG2 Failure (DG2 Failure)	Diesel generator 2 has failed.	Check diesel generator.
Grid is on (Grid is on)	AC is on grid.	--
Ambient Temp High 1 (Amb Temp High1)	High diesel generator ambient temperature alarm1.	Check why temperature is high or low.
Ambient Temp Low (Amb Temp Low)	Low diesel generator ambient temperature alarm.	
Ambient Temp High 2 (Amb Temp High2)	High diesel generator ambient temperature alarm2.	
Ambient Sensor Fault (AmbSensor Fault)	Diesel generator temperature sensor failure.	Replace temperature sensor.

Table 4

Full Alarm Name - WEB (Abbreviated Alarm Name - LCD)	Alarm Description	Action to Correct
DI1Alarm (DI1 Alarm)	Digital input #1 alarm is active.	Check why alarm is active.
...	...	
DI7Alarm (DI7 Alarm)	Digital input #7 alarm is active.	
DI8 ESTOP (DI8 ESTOP)	Digital input #8 alarm is active.	
IB Communication Fail (IB Comm Fail)	ACU+ Interface Board communications failure.	Check communications cables.
Relay Testing (Relay Testing)	Relay Test in progress.	--
Testing Relay 1 (Testing Relay 1)	Testing Relay 1 (on IB2 Board).	--
...	...	
Testing Relay 8 (Testing Relay 8)	Testing Relay 8 (on IB2 Board).	
System Temp1 High 2 (System T1 Hi2)	Temperature sensor #1 sensing temperature higher than high temperature threshold 2.	Note: This alarm is not used at this time.)
System Temp1 High 1 (System T1 Hi1)	Temperature sensor #1 sensing temperature higher than high temperature threshold 1.	
System Temp1 Low (System T1 Low)	Temperature sensor #1 sensing temperature lower than low temperature threshold.	
System Temp2 High 2 (System T2 Hi2)	Temperature sensor #2 sensing temperature higher than high temperature threshold 2.	Note: This alarm is not used at this time.)
System Temp2 High 1 (System T2 Hi1)	Temperature sensor #2 sensing temperature higher than high temperature threshold 1.	
System Temp2 Low (System T2 Low)	Temperature sensor #2 sensing temperature lower than low temperature threshold.	

Table 4

Full Alarm Name - WEB (Abbreviated Alarm Name - LCD)	Alarm Description	Action to Correct
System Temp3 High 2 (System T3 Hi2)	Temperature sensor #3 sensing temperature higher than high temperature threshold 2.	Note: This alarm is not used at this time.)
System Temp3 High 1 (System T3 Hi1)	Temperature sensor #3 sensing temperature higher than high temperature threshold 1.	
System Temp3 Low (System 31 Low)	Temperature sensor #3 sensing temperature lower than low temperature threshold.	
IB2 Temp1 High 2 (IB2 T1 Hi2)	Temperature sensor #1 (connected to IB2 board and set as Ambient) sensing temperature higher than high temperature threshold 2.	Check why temperature is high or low.
IB2 Temp1 High 1 (IB2 T1 Hi1)	Temperature sensor #1 (connected to IB2 board and set as Ambient) sensing temperature higher than high temperature threshold 1.	
IB2 Temp1 Low (IB2 T1 Low)	Temperature sensor #1 (connected to IB2 board and set as Ambient) sensing temperature lower than low temperature threshold.	
IB2 Temp2 High 2 (IB2 T2 Hi2)	Temperature sensor #2 (connected to IB2 board and set as Ambient) sensing temperature higher than high temperature threshold 2.	Check why temperature is high or low.
IB2 Temp2 High 1 (IB2 T2 Hi1)	Temperature sensor #2 (connected to IB2 board and set as Ambient) sensing temperature higher than high temperature threshold 1.	
IB2 Temp2 Low (IB2 T2 Low)	Temperature sensor #2 (connected to IB2 board and set as Ambient) sensing temperature lower than low temperature threshold.	

Table 4

Full Alarm Name - WEB (Abbreviated Alarm Name - LCD)	Alarm Description	Action to Correct
EIB Temp1 High 2 (EIB T1 Hi2)	Temperature sensor #1 (connected to EIB board and set as Ambient) sensing temperature higher than high temperature threshold 2.	Check why temperature is high or low.
EIB Temp1 High 1 (EIB T1 Hi1)	Temperature sensor #1 (connected to EIB board and set as Ambient) sensing temperature higher than high temperature threshold 1.	
EIB Temp1 Low (EIB T1 Low)	Temperature sensor #1 (connected to EIB board and set as Ambient) sensing temperature lower than low temperature threshold.	
EIB Temp2 High 2 (EIB T2 Hi2)	Temperature sensor #2 (connected to EIB board and set as Ambient) sensing temperature higher than high temperature threshold 2.	Check why temperature is high or low.
EIB Temp2 High 1 (EIB T2 Hi1)	Temperature sensor #2 (connected to EIB board and set as Ambient) sensing temperature higher than high temperature threshold 1.	
EIB Temp2 Low (EIB T2 Low)	Temperature sensor #2 (connected to EIB board and set as Ambient) sensing temperature lower than low temperature threshold.	
SMTemp1 Temp1 High 2 (SMTemp1 T1 Hi2)	Temperature sensor #1 (connected to SM-Temp 1 and set as Ambient) sensing temperature higher than high temperature threshold 2.	Check why temperature is high or low.
SMTemp1 Temp1 High 1 (SMTemp1 T1 Hi1)	Temperature sensor #1 (connected to SM-Temp 1 and set as Ambient) sensing temperature higher than high temperature threshold 1.	
SMTemp1 Temp1 Low (SMTemp1 T1 Low)	Temperature sensor #1 (connected to SM-Temp 1 and set as Ambient) sensing temperature lower than low temperature threshold.	
...

Table 4

Full Alarm Name - WEB (Abbreviated Alarm Name - LCD)	Alarm Description	Action to Correct
SMTemp1 Temp8 High 2 (SMTemp1 T8 Hi2)	Temperature sensor #8 (connected to SM-Temp 1 and set as Ambient) sensing temperature higher than high temperature threshold 2.	Check why temperature is high or low.
SMTemp1 Temp8 High 1 (SMTemp1 T8 Hi1)	Temperature sensor #8 (connected to SM-Temp 1 and set as Ambient) sensing temperature higher than high temperature threshold 1.	
SMTemp1 Temp8 Low (SMTemp1 T8 Low)	Temperature sensor #8 (connected to SM-Temp 1 and set as Ambient) sensing temperature lower than low temperature threshold.	
...
SMTemp8 Temp1 High 2 (SMTemp8 T1 Hi2)	Temperature sensor #1 (connected to SM-Temp 8 and set as Ambient) sensing temperature higher than high temperature threshold 2.	Check why temperature is high or low.
SMTemp8 Temp1 High 1 (SMTemp8 T1 Hi1)	Temperature sensor #1 (connected to SM-Temp 8 and set as Ambient) sensing temperature higher than high temperature threshold 1.	
SMTemp8 Temp1 Low (SMTemp8 T1 Low)	Temperature sensor #1 (connected to SM-Temp 8 and set as Ambient) sensing temperature lower than low temperature threshold.	
...
SMTemp8 Temp8 High 2 (SMTemp8 T8 Hi2)	Temperature sensor #8 (connected to SM-Temp 8 and set as Ambient) sensing temperature higher than high temperature threshold 2.	Check why temperature is high or low.
SMTemp8 Temp8 High 1 (SMTemp8 T8 Hi1)	Temperature sensor #8 (connected to SM-Temp 8 and set as Ambient) sensing temperature higher than high temperature threshold 1.	
SMTemp8 Temp8 Low (SMTemp8 T8 Low)	Temperature sensor #8 (connected to SM-Temp 8 and set as Ambient) sensing temperature lower than low temperature threshold.	

Table 4

Full Alarm Name - WEB (Abbreviated Alarm Name - LCD)	Alarm Description	Action to Correct
High Load Level1 (HighLoadLevel1)	Load current above high level 1.	Check to see why load current is high.
High Load Level2 (HighLoadLevel2)	Load current above high level 2.	
Load Current Alarm (Load Curr Alarm)	Load current alarm active.	Check to see why load current alarm is active.
Rectifier Group Alarms (Rect Group)		
Multiple Rectifiers Failure (Multi-Rect Fail)	More than one rectifier has failed.	Check input voltage to rectifiers. Replace rectifiers.
Rectifier Lost (Rectifier Lost)	A rectifier cannot be detected by the Controller.	Reset the Rectifier Lost alarm. Replace defective rectifier.
ECO Active (ECO Active)	Rectifier Energy Optimization Mode is enabled.	Check to see why system was placed into this mode.
All Rectifiers Comm Fail (AllRectCommFail)	No response from all rectifiers.	Check the connectors and cables or the CAN loop. Replace the Controller.
ECO Cycle Alarm (ECO Cycle Alarm)	If Energy Optimization Mode is enabled and the Controller oscillates in and out of Energy Optimization more than 5 times, this alarm is generated.	Check for other alarms. Reset this alarm.
Rectifier Alarms (Rectifier)		
AC Input Failure (AC Failure)	No AC input power to a rectifier.	Check why no AC input power available.
Rect Temperature High (Rect Temp High)	A rectifier has a high temperature condition.	Check why temperature is high.
Rectifier Fault (Rect Fault)	A rectifier has a fault condition.	Refer to Rectifier User Manual for troubleshooting information.
HVSD (HVSD)	A rectifier has an overvoltage condition.	
Rectifier Protected (Rect Protected)	A rectifier is in protected mode.	
Fan Failure (Fan Failure)	A rectifier's fan has failed.	Replace fan.

Table 4

Full Alarm Name - WEB (Abbreviated Alarm Name - LCD)	Alarm Description	Action to Correct
Current Limit (Current Limit)	A rectifier is in current limit.	Rectifier overload. The load is higher than rectifier capacity. If the batteries are being recharged, the alarm will cease by itself when the battery voltage has increased to the charging level. If the system load is higher than the rectifier capacity, the batteries will discharge. If this is the reason, install additional rectifiers. If one or more of the rectifiers are defective, replace the faulty rectifiers.
Rectifier Communication Fail (Rect Comm Fail)	A rectifier has lost communications with the Controller.	Check communications cables. Reset the Communication Fail alarm. Replace the rectifier.
Derated (Derated)	A rectifier is in output power derating mode.	Refer to Rectifier User Manual for troubleshooting information.
Current Share Alarm (Curr Share Alm)	A rectifier has a current sharing alarm.	
AC Under Voltage Protection (Low AC Protect)	A rectifier is in under voltage protection mode.	
Battery Group Alarms (Battery Group)		
Short Battery Test Running (ShortBatTestRun)	Battery is in short time test mode.	--
Equalize for Test (EQ for Test)	Battery is in equalize charge test mode.	--
Manual Test (Manual Test)	Battery is in manual battery discharge test mode.	--
Planned Test (Planned Test)	Battery is in planned battery test mode.	--
AC Fail Test (AC Fail Test)	AC power has been switched off to the rectifiers to perform a battery discharge test.	--
Manual Equalize (Manual EQ)	Battery is in manual equalize charging mode.	--
Automatic Equalize (Auto EQ)	Battery is in automatic equalize charging mode.	--
Cyclic Equalize (Cyclic EQ)	Battery is in cyclic equalize charging mode.	--

Table 4

Full Alarm Name - WEB (Abbreviated Alarm Name - LCD)	Alarm Description	Action to Correct
Master Equalize (Master EQ)	In slave mode, the slave unit starts equalize charging with the master unit.	--
Master Battery Test (Master Bat Test)	In slave mode, the slave unit starts the test with the master unit.	--
Discharge Current Imbalance (Dsch Curr Imb)	Battery distribution current imbalance alarm.	The currents from two groups of batteries are not equal. Check the batteries.
Abnormal Battery Current (Abnl Batt Curr)	The equalize charging current exceeds the alarm setting.	Check the alarm setting.
Temperature Compensation Active (TempComp Active)	Battery charge temperature compensation is active.	--
Battery Current Limit Active (Batt Curr Limit)	Battery is in current limit.	--
Bad Battery (Bad Battery)	Battery test fails.	Check the batteries.
Battery Discharge (Battery Disch)	Battery is discharging.	A battery test is active (the discharge test will stop automatically). There is a mains failure (check that it is not caused by open AC input circuit breaker). The system load is higher than rectifier capacity, causing the batteries to discharge (install additional rectifiers).
Battery Test Fail (BatteryTestFail)	Battery test fails.	Check the batteries.
Comp Temp High2 (Comp Temp High2)	Compensation temperature sensor sensing temperature higher than high temperature threshold 2.	Check why temperature is high or low.
Comp Temp High1 (Comp Temp High1)	Compensation temperature sensor sensing temperature higher than high temperature threshold 1.	
Comp Temp Low (Comp Temp Low)	Compensation temperature sensor sensing temperature lower than low temperature threshold.	
Compensation Sensor Fault (CompTempFail)	Temperature Compensation temperature sensor failure.	Replace temperature sensor.

Table 4

Full Alarm Name - WEB (Abbreviated Alarm Name - LCD)	Alarm Description	Action to Correct
System Temp1 High 2 (System T1 Hi2)	Temperature sensor #1 sensing temperature higher than high temperature threshold 2.	Note: This alarm is not used at this time.)
System Temp1 High 1 (System T1 Hi1)	Temperature sensor #1 sensing temperature higher than high temperature threshold 1.	
System Temp1 Low (System T1 Low)	Temperature sensor #1 sensing temperature lower than low temperature threshold.	
System Temp2 High 2 (System T2 Hi2)	Temperature sensor #2 sensing temperature higher than high temperature threshold 2.	Note: This alarm is not used at this time.)
System Temp2 High 1 (System T2 Hi1)	Temperature sensor #2 sensing temperature higher than high temperature threshold 1.	
System Temp2 Low (System T2 Low)	Temperature sensor #2 sensing temperature lower than low temperature threshold.	
System Temp3 High 2 (System T3 Hi2)	Temperature sensor #3 sensing temperature higher than high temperature threshold 2.	Note: This alarm is not used at this time.)
System Temp3 High 1 (System T3 Hi1)	Temperature sensor #3 sensing temperature higher than high temperature threshold 1.	
System Temp3 Low (System T3 Low)	Temperature sensor #3 sensing temperature lower than low temperature threshold.	
IB2 Temp1 High 2 (IB2 T1 Hi2)	Temperature sensor #1 (connected to IB2 board and set as Battery) sensing temperature higher than high temperature threshold 2.	Check why temperature is high or low.
IB2 Temp1 High 1 (IB2 T1 Hi1)	Temperature sensor #1 (connected to IB2 board and set as Battery) sensing temperature higher than high temperature threshold 1.	
IB2 Temp1 Low (IB2 T1 Low)	Temperature sensor #1 (connected to IB2 board and set as Battery) sensing temperature lower than low temperature threshold.	

Table 4

Full Alarm Name - WEB (Abbreviated Alarm Name - LCD)	Alarm Description	Action to Correct
IB2 Temp2 High 2 (IB2 T2 Hi2)	Temperature sensor #2 (connected to IB2 board and set as Battery) sensing temperature higher than high temperature threshold 2.	Check why temperature is high or low.
IB2 Temp2 High 1 (IB2 T2 Hi1)	Temperature sensor #2 (connected to IB2 board and set as Battery) sensing temperature higher than high temperature threshold 1.	
IB2 Temp2 Low (IB2 T2 Low)	Temperature sensor #2 (connected to IB2 board and set as Battery) sensing temperature lower than low temperature threshold.	
EIB Temp1 High 2 (EIB T1 Hi2)	Temperature sensor #1 (connected to EIB board and set as Battery) sensing temperature higher than high temperature threshold 2.	Check why temperature is high or low.
EIB Temp1 High 1 (EIB T1 Hi1)	Temperature sensor #1 (connected to EIB board and set as Battery) sensing temperature higher than high temperature threshold 1.	
EIB Temp1 Low (EIB T1 Low)	Temperature sensor #1 (connected to EIB board and set as Battery) sensing temperature lower than low temperature threshold.	
EIB Temp2 High 2 (EIB T2 Hi2)	Temperature sensor #2 (connected to EIB board and set as Battery) sensing temperature higher than high temperature threshold 2.	Check why temperature is high or low.
EIB Temp2 High 1 (EIB T2 Hi1)	Temperature sensor #2 (connected to EIB board and set as Battery) sensing temperature higher than high temperature threshold 1.	
EIB Temp2 Low (EIB T2 Low)	Temperature sensor #2 (connected to EIB board and set as Battery) sensing temperature lower than low temperature threshold.	

Table 4

Full Alarm Name - WEB (Abbreviated Alarm Name - LCD)	Alarm Description	Action to Correct
SMTemp1 Temp1 High 2 (SMTemp1 T1 Hi2)	Temperature sensor #1 (connected to SM-Temp 1 and set as Battery) sensing temperature higher than high temperature threshold 2.	Check why temperature is high or low.
SMTemp1 Temp1 High 1 (SMTemp1 T1 Hi1)	Temperature sensor #1 (connected to SM-Temp 1 and set as Battery) sensing temperature higher than high temperature threshold 1.	
SMTemp1 Temp1 Low (SMTemp1 T1 Low)	Temperature sensor #1 (connected to SM-Temp 1 and set as Battery) sensing temperature lower than low temperature threshold.	
...
SMTemp1 Temp8 High 2 (SMTemp1 T8 Hi2)	Temperature sensor #8 (connected to SM-Temp 1 and set as Battery) sensing temperature higher than high temperature threshold 2.	Check why temperature is high or low.
SMTemp1 Temp8 High 1 (SMTemp1 T8 Hi1)	Temperature sensor #8 (connected to SM-Temp 1 and set as Battery) sensing temperature higher than high temperature threshold 1.	
SMTemp1 Temp8 Low (SMTemp1 T8 Low)	Temperature sensor #8 (connected to SM-Temp 1 and set as Battery) sensing temperature lower than low temperature threshold.	
...
SMTemp8 Temp1 High 2 (SMTemp8 T1 Hi2)	Temperature sensor #1 (connected to SM-Temp 8 and set as Battery) sensing temperature higher than high temperature threshold 2.	Check why temperature is high or low.
SMTemp8 Temp1 High 1 (SMTemp8 T1 Hi1)	Temperature sensor #1 (connected to SM-Temp 8 and set as Battery) sensing temperature higher than high temperature threshold 1.	
SMTemp8 Temp1 Low (SMTemp8 T1 Low)	Temperature sensor #1 (connected to SM-Temp 8 and set as Battery) sensing temperature lower than low temperature threshold.	
...

Table 4

Full Alarm Name - WEB (Abbreviated Alarm Name - LCD)	Alarm Description	Action to Correct
SMTemp8 Temp8 High 2 (SMTemp8 T8 Hi2)	Temperature sensor #8 (connected to SM-Temp 8 and set as Battery) sensing temperature higher than high temperature threshold 2.	Check why temperature is high or low.
SMTemp8 Temp8 High 1 (SMTemp8 T8 Hi1)	Temperature sensor #8 (connected to SM-Temp 8 and set as Battery) sensing temperature higher than high temperature threshold 1.	
SMTemp8 Temp8 Low (SMTemp8 T8 Low)	Temperature sensor #8 (connected to SM-Temp 8 and set as Battery) sensing temperature lower than low temperature threshold.	
BTRM Temp High 2 (BTRM Temp High2)	Battery temperature (monitored by the sensor set as BTRM) is higher than the BTRM Temperature Alarm 2 threshold.	Check why temperature is high or low.
BTRM Temp High 1 (BTRM Temp High1)	Battery temperature (monitored by the sensor set as BTRM) is higher than the BTRM Temperature Alarm 1 threshold.	
BTRM Sensor Fault (BTRM TempFault)	BTRM temperature sensor failure.	Replace temperature sensor.
Li-Ion Battery Lost (LiBatt Lost)	A Li-Ion Battery cannot be detected by the Controller.	Check communications cables. Clear the Li-Ion Battery Lost alarm.
1 Li-Ion Battery Disconnect (1 LiBattDiscon)	One (1) Li-Ion Battery is disconnected.	Check why the Li-Ion Battery disconnected.
2+Li-Ion Battery Disconnect (2+LiBattDiscon)	Two (2) or more Li-Ion Batteries are disconnected.	Check why the Li-Ion Batteries disconnected.
1 Li-Ion Battery No Reply (1 LiBattNoReply)	One (1) Li-Ion Battery has lost communications with the Controller.	Check communications cables. Clear the Li-Ion Communication Fail alarm.
2+Li-Ion Battery No Reply (2+LiBattNoReply)	Two (2) or more Li-Ion Batteries have lost communications with the Controller.	Check communications cables. Clear the Li-Ion Communication Fail alarm.
Inventory Update In Process (InventUpdating)	Li-Ion Battery inventory being updated.	--
ABCL is active (ABCL Active)	Active Battery Charge Current Limit is active.	--

Table 4

Full Alarm Name - WEB (Abbreviated Alarm Name - LCD)	Alarm Description	Action to Correct
Battery Alarms (Battery)		
Battery Current Limit Exceeded (Ov Batt Cur Lmt)	Battery current limit point is exceeded.	--
Battery Over Current (Batt Over Curr)	Battery is in over current.	--
Low Battery Capacity (Low Batt Cap)	Battery has low capacity.	Check the batteries.
SMDU Battery Alarms (SM-DU Module must be present in system) (SMDU Battery)		
Exceed Current Limit (Exceed Curr Lmt)	Battery current limit point is exceeded.	--
Over Battery Current (Over Current)	Battery is in over current.	--
Low Capacity (Low Capacity)	Battery has low capacity.	Check the batteries.
EIB (Extended Interface Board) Battery Alarms (EIB Board must be present in system) (EIB Battery)		
Battery Current Limit Exceeded (Ov Bat Curr Lmt)	Battery current limit point is exceeded.	--
Battery Over Current (Bat Over Curr)	Battery is in over current.	--
Battery Low Capacity (Low Batt Cap)	Battery has low capacity.	Check the batteries.
SM Battery Alarms (SM-BAT Module must be present in system) (SM Battery)		
Exceed Batt Current Limit (Over Curr Limit)	Battery is in over current.	--
Over Battery Current (Over Batt Curr)	Battery current is high.	--
Battery Leakage (Battery Leakage)	Battery has leakage current.	Check the batteries.
Low Acid Level (Low Acid Level)	Battery has low acid level.	Check the batteries.

Table 4

Full Alarm Name - WEB (Abbreviated Alarm Name - LCD)	Alarm Description	Action to Correct
Battery Disconnected (Batt Disconnec)	Battery disconnection is active.	--
Battery High Temperature (Batt High Temp)	Battery has high temperature condition.	--
Battery Low Temperature (Batt Low Temp)	Battery has low temperature condition.	--
Cell Voltage Difference (Cell Volt Diff)	Battery cell voltage difference detected.	Check the batteries.
SM Unit Fail (SM Unit Fail)	Battery monitoring device has failed.	Replace device.
Battery Temperature Sensor Fault (T Sensor Fault)	Battery temperature sensor has failed.	Replace temperature sensor.
Low Capacity (Low Capacity)	Battery has low capacity.	Check the batteries.
Battery Communication Fail (Batt Comm Fail)	Battery monitoring device has lost communications with the Controller.	Check communications cables.
Battery Temp not Used (Bat Temp No Use)	No battery temperature sensor.	--
LargeDU Battery Alarms (Large Distribution Unit must be present in system) (LargeDU Batt)		
Battery Current Limit Exceeded (Ov Batt Cur Lmt)	Battery current limit point is exceeded.	--
Battery Low Capacity (Batt Low Cap)	Battery has low capacity.	Check the batteries.
Battery Fuse Failure (Batt Fuse Fail)	Battery fuse is open.	--
Battery Over Voltage (Batt Over Volt)	Battery has over voltage condition.	--
Battery Under Voltage (Batt Under Volt)	Battery has under voltage condition.	--
Battery Over Current (Batt Over Curr)	Battery has over current condition.	--
Communication Fail (Comm Fail)	Battery monitoring device has lost communications with the Controller.	Check communications cables.

Table 4

Full Alarm Name - WEB (Abbreviated Alarm Name - LCD)	Alarm Description	Action to Correct
SMBRC Battery Alarms (SM-BRC Module must be present in system) (SMBRC Battery)		
Cell Volt Low Alarm (Volt Low Alm)	Battery string low voltage alarm.	--
Cell Temp Low Alarm (Temp Low Alm)	Battery string low temperature alarm.	--
Cell Resist Low Alarm (Resist Low Alm)	Battery string low resistance alarm.	--
Cell Inter Low Alarm (Inter Low Alm)	Battery string inter-cell low resistance alarm.	--
Cell Ambient Low Alarm (Amb Low Alm)	Battery string ambient low alarm.	--
Overall Voltage High (Overall Volt Hi)	Battery string high voltage alarm.	--
Overall Voltage Low (Overall Volt Lo)	Battery string low voltage alarm.	--
String Current High (String Curr Hi)	Battery string high current alarm.	--
String Current Low (String Curr Lo)	Battery string low current alarm.	--
Ripple Current High (Ripple Curr Hi)	Battery string ripple current high.	--
Ripple Current Low (Ripple Curr Lo)	Battery string ripple current low.	--
Exceed Current Limit (Exceed Curr Lmt)	Battery string current limit exceeded.	--
Over Battery Current (Over Current)	Battery string over current alarm.	--
Low Capacity (Low Capacity)	Battery string low capacity alarm.	--
Cell High Voltage Alarm (Cell HiVolt Alm)	Battery cell high voltage alarm.	--
Cell High Cell Temperature Alarm (Cell HiTemp Alm)	Battery cell high temperature alarm.	--

Table 4

Full Alarm Name - WEB (Abbreviated Alarm Name - LCD)	Alarm Description	Action to Correct
Cell High Resistance Alarm (Cell HiRes Alm)	Battery cell high resistance alarm.	--
Cell High Intercell Resist Alarm (Inter HiRes Alm)	Battery inter-cell high resistance alarm.	--
Cell High Ambient Temp Alarm (Cell HiAmb Alm)	Battery cell high ambient temperature alarm.	--
Temperature 1 Not Used (Temp1 Not Used)	Temperature sensor #1 not used.	--
...	...	
Temperature 24 Not Used (Temp24 Not Used)	Temperature sensor #24 not used.	
Battery Temperature Fault (Batt Temp Fault)	Li-Ion battery internal temperature sensor has failed.	Replace the battery.
Battery Current Fault (Current Fault)	Li-Ion battery internal current monitoring circuit has failed.	Replace the battery.
Battery Hardware Failure (Hardware Fail)	Li-Ion battery hardware has failed.	Replace the battery.
Battery Over-Voltage (Over-volt)	Li-Ion battery has over voltage condition.	Check why battery voltage is high.
Battery Low-Voltage (Low-volt)	Li-Ion battery has low voltage condition.	Check why battery voltage is low.
Cell Volt Deviation (CellVoltDeviat)	Li-Ion battery cell voltage deviation detected.	Check why cell voltage has deviated.
Low Cell Voltage (Lo Cell Volt)	Li-Ion battery has low cell voltage condition.	Check why cell voltage is low.
High Cell Voltage (Hi Cell Volt)	Li-Ion battery has high cell voltage condition.	Check why cell voltage is high.
High Cell Temperature (Hi Cell Temp)	Li-Ion battery has high cell temperature condition.	Check why temperature is high.
High Switch DisTemp (HiSwitchDisTemp)	Li-Ion battery has high switch discharge temperature.	Check why temperature is high.
Charge Short Circuit (Char ShortCirc)	Li-Ion battery has charge short circuit condition.	Replace the battery.

Table 4

Full Alarm Name - WEB (Abbreviated Alarm Name - LCD)	Alarm Description	Action to Correct
DisChar Short Circuit (DisCharShortCir)	Li-Ion battery has discharge short circuit condition.	Replace the battery.
High Switch CharTemp (HiSwitchCharTem)	Li-Ion battery has high switch charge temperature.	Check why temperature is high.
Hardware Fail 20 (HardwareFail20)	Li-Ion battery has hardware failure.	Replace the battery.
Hardware Fail 21 (HardwareFail21)	Li-Ion battery has hardware failure.	Replace the battery.
High Charge Current (Hi Charge Curr)	Li-Ion battery has high charge current.	Check why charge current high.
High DisCharge Current (Hi Dischar Curr)	Li-Ion battery has high discharge current.	Check why discharge current high.
Communication Interrupt (Comm Interrupt)	Li-Ion battery communications have been interrupted.	Check why communications failure.
Battery Disconnected (Batt Disconnect)	Li-Ion battery is disconnected.	Check why battery disconnected.
Charge Enabled (Charge Enable)	Li-Ion battery charge is enabled.	--
Battery Discharging (Batt Discharge)	Li-Ion battery is discharging.	--
Battery Charging (Batt Charge)	Li-Ion battery is charging.	--
DisCharging (DisCharging)	Li-Ion battery is discharging.	--
Charging(5A) (Charging(5A))	Li-Ion battery is charging.	--
DisCharging(5A) (DisCharging(5A))	Li-Ion battery is discharging.	--
Battery Relay Status (BattRelayStatus)	State of alarm relay.	If in alarm state, check battery.

Table 4

Full Alarm Name - WEB (Abbreviated Alarm Name - LCD)	Alarm Description	Action to Correct
OB Battery Fuse Alarms (SM-DU Module must be present in system) (OB Batt Fuse)		
Fuse 1 Alarm (Fuse 1 Alarm)	Fuse #1 is open.	Find out and eliminate the reason the fuse is open before replacing. Check for overload or short circuit. If the fuse was manually removed, check with the person that removed it before reinserting it.
...	...	
Fuse 4 Alarm (Fuse 4 Alarm)	Fuse #4 is open.	
SMDU Battery Fuse Unit Alarms (SM-DU Module must be present in system) (SMDU Bat Fuse)		
Batt Fuse 1 Alarm (Batt Fuse 1 Alm)	Battery fuse #1 is open.	Find out and eliminate the reason the fuse is open before replacing. Check for overload or short circuit. If the fuse was manually removed, check with the person that removed it before reinserting it.
...	...	
Batt Fuse 4 Alarm (Batt Fuse 4 Alm)	Battery fuse #4 is open.	
DC Distribution Alarms (DC Distr)		
Over Voltage 1 (Over Voltage 1)	DC output is above over voltage 1 threshold.	Check to see why voltage is high.
Over Voltage 2 (Over Voltage 2)	DC output is above over voltage 2 threshold.	
Under Voltage 1 (Under Voltage 1)	DC output is below under voltage 1 threshold.	Check to see why voltage is low.
Under Voltage 2 (Under Voltage 2)	DC output is below under voltage 2 threshold.	
Over Voltage 1 (24V) (24V Over Volt1)	DC output is above over voltage 1 threshold.	Check to see why voltage is high.
Over Voltage 2 (24V) (24V Over Volt2)	DC output is above over voltage 2 threshold.	
Under Voltage 1 (24V) (24V Under Volt1)	DC output is below under voltage 1 threshold.	Check to see why voltage is low.
Under Voltage 2 (24V) (24V Under Volt2)	DC output is below under voltage 2 threshold.	

Table 4

Full Alarm Name - WEB (Abbreviated Alarm Name - LCD)	Alarm Description	Action to Correct
DC Fuse Unit Alarms (DC Fuse Unit)		
Fuse 1 Alarm (Fuse 1 Alarm)	DC output fuse #1 is open.	Find out and eliminate the reason the fuse is open before replacing. Check for overload or short circuit. If the fuse was manually removed, check with the person that removed it before reinserting it.
...	...	
Fuse 10 Alarm (Fuse 10 Alarm)	DC output fuse #10 is open.	
SMDU DC Fuse Alarms (SM-DU Module must be present in system) (SMDU DC Fuse)		
Fuse 1 Alarm (DC Fuse 1 Alm)	DC output fuse #1 is open.	Find out and eliminate the reason the fuse is open before replacing. Check for overload or short circuit. If the fuse was manually removed, check with the person that removed it before reinserting it.
...	...	
Fuse 16 Alarm (DC Fuse 16 Alm)	DC output fuse #16 is open.	
SMDUP DC Fuse Alarms (SM-DU+ Module must be present in system) (SMDUP DC Fuse)		
Fuse 1 Alarm (DC Fuse 1 Alm)	DC output fuse #1 is open.	Find out and eliminate the reason the fuse is open before replacing. Check for overload or short circuit. If the fuse was manually removed, check with the person that removed it before reinserting it.
...	...	
Fuse 25 Alarm (DC Fuse 25 Alm)	DC output fuse #25 is open.	
LVD Unit Alarms (Low voltage disconnect must be present in system) (LVD Unit)		
LVD1 Disconnect (LVD1 Disconnect)	LVD1 contactor is in disconnect mode.	--
LVD2 Disconnect (LVD2 Disconnect)	LVD2 contactor is in disconnect mode.	--
LVD1 Failure (LVD1 Failure)	LVD1 contactor has failed.	Check the contactor functions. Replace the contactor.
LVD2 Failure (LVD2 Failure)	LVD2 contactor has failed.	
SMDU LVD Alarms (SM-DU Module must be present in system) (SMDU LVD)		
LVD 1 Disconnected (LVD 1 Disconn)	LVD1 contactor is in disconnect mode.	--

Table 4

Full Alarm Name - WEB (Abbreviated Alarm Name - LCD)	Alarm Description	Action to Correct
LVD 2 Disconnected (LVD 2 Disconn)	LVD2 contactor is in disconnect mode.	--
LVD 1 Contactor Failure (LVD 1 Failure)	LVD1 contactor has failed.	Check the contactor functions. Replace the contactor.
LVD 2 Contactor Failure (LVD 2 Failure)	LVD2 contactor has failed.	
LargeDU LVD Alarms (Large Distribution Unit must be present in system) (LargeDU LVD)		
LVD1 Disconnected (LVD1 Disconnect)	LVD1 contactor is in disconnect mode.	--
LVD2 Disconnected (LVD2 Disconnect)	LVD2 contactor is in disconnect mode.	--
Rectifier AC Alarms (Rectifier AC)		
Line AB Over Voltage 1 (L-AB Over Volt1)	Voltage between Line A and Line B is higher than the High Line Voltage AB Alarm threshold.	Check why voltage is high.
Line AB Over Voltage 2 (L-AB Over Volt2)	Voltage between Line A and Line B is higher than the Very High Line Voltage AB Alarm threshold.	
Line AB Under Voltage 1 (L-AB UnderVolt1)	Voltage between Line A and Line B is lower than the Low Line Voltage AB Alarm threshold.	Check why voltage is low.
Line AB Under Voltage 2 (L-AB UnderVolt2)	Voltage between Line A and Line B is lower than the Very Low Line Voltage AB Alarm threshold.	
Line BC Over Voltage 1 (L-BC Over Volt1)	Voltage between Line B and Line C is higher than the High Line Voltage BC Alarm threshold.	Check why voltage is high.
Line BC Over Voltage 2 (L-BC Over Volt2)	Voltage between Line B and Line C is higher than the Very High Line Voltage BC Alarm threshold.	
Line BC Under Voltage 1 (L-BC UnderVolt1)	Voltage between Line B and Line C is lower than the Low Line Voltage BC Alarm threshold.	Check why voltage is low.
Line BC Under Voltage 2 (L-BC UnderVolt2)	Voltage between Line B and Line C is lower than the Very Low Line Voltage BC Alarm threshold.	

Table 4

Full Alarm Name - WEB (Abbreviated Alarm Name - LCD)	Alarm Description	Action to Correct
Line CA Over Voltage 1 (L-CA Over Volt1)	Voltage between Line C and Line A is higher than the High Line Voltage CA Alarm threshold.	Check why voltage is high.
Line CA Over Voltage 2 (L-CA Over Volt2)	Voltage between Line C and Line A is higher than the Very High Line Voltage CA Alarm threshold.	
Line CA Under Voltage 1 (L-CA UnderVolt1)	Voltage between Line C and Line A is lower than the Low Line Voltage CA Alarm threshold.	Check why voltage is low.
Line CA Under Voltage 2 (L-CA UnderVolt2)	Voltage between Line C and Line A is lower than the Very Low Line Voltage CA Alarm threshold.	
Phase A Over Voltage 1 (PH-A Over Volt1)	Phase A voltage is above over voltage 1 threshold.	Check why voltage is high.
Phase A Over Voltage 2 (PH-A Over Volt2)	Phase A voltage is above over voltage 2 threshold.	
Phase A Under Voltage 1 (PH-A UnderVolt1)	Phase A voltage is below under voltage 1 threshold.	Check why voltage is low.
Phase A Under Voltage 2 (PH-A UnderVolt2)	Phase A voltage is below under voltage 2 threshold.	
Phase B Over Voltage 1 (PH-B Over Volt1)	Phase B voltage is above over voltage 1 threshold.	Check why voltage is high.
Phase B Over Voltage 2 (PH-B Over Volt2)	Phase B voltage is above over voltage 2 threshold.	
Phase B Under Voltage 1 (PH-B UnderVolt1)	Phase B voltage is below under voltage 1 threshold.	Check why voltage is low.
Phase B Under Voltage 2 (PH-B UnderVolt2)	Phase B voltage is below under voltage 2 threshold.	
Phase C Over Voltage 1 (PH-C Over Volt1)	Phase C voltage is above over voltage 1 threshold.	Check why voltage is high.
Phase C Over Voltage 2 (PH-C Over Volt2)	Phase C voltage is above over voltage 2 threshold.	
Phase C Under Voltage 1 (PH-C UnderVolt1)	Phase C voltage is below under voltage 1 threshold.	Check why voltage is low.
Phase C Under Voltage 2 (PH-C UnderVolt2)	Phase C voltage is below under voltage 2 threshold.	

Table 4

Full Alarm Name - WEB (Abbreviated Alarm Name - LCD)	Alarm Description	Action to Correct
Mains Failure (Mains Failure)	Commercial AC power failure.	Check why no commercial AC power.
OB AC Unit (OB-AC Module must be present in system) (OBAC)		
Phase A Over Voltage 1 (PH-A Over Volt1)	Phase A voltage is above over voltage 1 threshold.	Check why voltage is high.
Phase A Over Voltage 2 (PH-A Over Volt2)	Phase A voltage is above over voltage 2 threshold.	
Phase A Under Voltage 1 (PH-A UnderVolt1)	Phase A voltage is below under voltage 1 threshold.	Check why voltage is low.
Phase A Under Voltage 2 (PH-A UnderVolt2)	Phase A voltage is below under voltage 2 threshold.	
Phase B Over Voltage 1 (PH-B Over Volt1)	Phase B voltage is above over voltage 1 threshold.	Check why voltage is high.
Phase B Over Voltage 2 (PH-B Over Volt2)	Phase B voltage is above over voltage 2 threshold.	
Phase B Under Voltage 1 (PH-B UnderVolt1)	Phase B voltage is below under voltage 1 threshold.	Check why voltage is low.
Phase B Under Voltage 2 (PH-B UnderVolt2)	Phase B voltage is below under voltage 2 threshold.	
Phase C Over Voltage 1 (PH-C Over Volt1)	Phase C voltage is above over voltage 1 threshold.	Check why voltage is high.
Phase C Over Voltage 2 (PH-C Over Volt2)	Phase C voltage is above over voltage 2 threshold.	
Phase C Under Voltage 1 (PH-C UnderVolt1)	Phase C voltage is below under voltage 1 threshold.	Check why voltage is low.
Phase C Under Voltage 2 (PH-C UnderVolt2)	Phase C voltage is below under voltage 2 threshold.	
Mains Failure (Mains Failure)	Commercial AC power failure.	Check why no commercial AC power.
Severe Mains Failure (SevereMainsFail)	Commercial AC power voltage is too low.	Check why voltage is low.
Mains Failure (Single) (Mains Failure)	Commercial AC power failure.	Check why no commercial AC power.
Severe Mains Failure (Single) (SevereMainsFail)	Commercial AC power voltage is too low.	Check why voltage is low.

Table 4

Full Alarm Name - WEB (Abbreviated Alarm Name - LCD)	Alarm Description	Action to Correct
SMAC Alarms (SM-AC Module must be present in system) (SMAC)		
Supervision Fail (Supervise Fail)	AC monitoring device has failed.	--
High Line Voltage AB (Hi LineVolt AB)	Voltage between Line A and Line B above high voltage threshold.	Check why voltage is high.
Very High Line Voltage AB (VHi LineVolt AB)	Voltage between Line A and Line B above very high voltage threshold.	
Low Line Voltage AB (Lo LineVolt AB)	Voltage between Line A and Line B below low voltage threshold.	Check why voltage is low.
Very Low Line Voltage AB (VLo LineVolt AB)	Voltage between Line A and Line B below very low voltage threshold.	
High Line Voltage BC (Hi LineVolt BC)	Voltage between Line B and Line C above high voltage threshold.	Check why voltage is high.
Very High Line Voltage BC (VHi LineVolt BC)	Voltage between Line B and Line C above very high voltage threshold.	
Low Line Voltage BC (Lo LineVolt BC)	Voltage between Line B and Line C below low voltage threshold.	Check why voltage is low.
Very Low Line Voltage BC (VLo LineVolt BC)	Voltage between Line B and Line C below very low voltage threshold.	
High Line Voltage CA (Hi LineVolt CA)	Voltage between Line C and Line A above high voltage threshold.	Check why voltage is high.
Very High Line Voltage CA (VHi LineVolt CA)	Voltage between Line C and Line A above very high voltage threshold.	
Low Line Voltage CA (Lo LineVolt CA)	Voltage between Line C and Line A below low voltage threshold.	Check why voltage is low.
Very Low Line Voltage CA (VLo LineVolt CA)	Voltage between Line C and Line A below very low voltage threshold.	
High Phase Voltage A (Hi PhaseVolt A)	Phase A voltage is above high voltage threshold.	Check why voltage is high.
Very High Phase Voltage A (VHi PhaseVolt A)	Phase A voltage is above very high voltage threshold.	
Low Phase Voltage A (Lo PhaseVolt A)	Phase A voltage is below low voltage threshold.	Check why voltage is low.
Very Low Phase Voltage A (VLo PhaseVolt A)	Phase A voltage is below very low voltage threshold.	

Table 4

Full Alarm Name - WEB (Abbreviated Alarm Name - LCD)	Alarm Description	Action to Correct
High Phase Voltage B (Hi PhaseVolt B)	Phase B voltage is above high voltage threshold.	Check why voltage is high.
Very High Phase Voltage B (VHi PhaseVolt B)	Phase B voltage is above very high voltage threshold.	
Low Phase Voltage B (Lo PhaseVolt B)	Phase B voltage is below low voltage threshold.	Check why voltage is low.
Very Low Phase Voltage B (VLo PhaseVolt B)	Phase B voltage is below very low voltage threshold.	
High Phase Voltage C (Hi PhaseVolt C)	Phase C voltage is above high voltage threshold.	Check why voltage is high.
Very High Phase Voltage C (VHi PhaseVolt C)	Phase C voltage is above very high voltage threshold.	
Low Phase Voltage C (Lo PhaseVolt C)	Phase C voltage is below low voltage threshold.	Check why voltage is low.
Very Low Phase Voltage C (VLo PhaseVolt C)	Phase C voltage is below very low voltage threshold.	
Mains Failure (Mains Failure)	Commercial AC power failure.	Check why no commercial AC power.
Severe Mains Failure (SevereMainsFail)	Commercial AC power voltage is too low.	Check why voltage is low.
High Frequency (High Frequency)	Commercial AC power has high frequency.	--
Low Frequency (Low Frequency)	Commercial AC power has low frequency.	--
High Temperature (High Temp)	AC input temperature sensor sensing high temperature condition.	--
Low Temperature (Low Temperature)	AC input temperature sensor sensing low temperature condition.	--
Phase A High Current (PH-A Hi Current)	High phase A current.	--
Phase B High Current (PH-B Hi Current)	High phase B current.	--
Phase C High Current (PH-C Hi Current)	High phase C current.	--

Table 4

Full Alarm Name - WEB (Abbreviated Alarm Name - LCD)	Alarm Description	Action to Correct
IB (Interface Board) Alarms (IB board must be present in system) (IB)		
Communication Fail (Comm Fail)	IB board has lost communications with the Controller.	Check communications cables.
Digital Input 1 Alarm (D11 Alarm)	Digital input #1 in alarm state.	--
...
Digital Input 8 Alarm (D18 Alarm)	Digital input #8 in alarm state.	--
Testing Relay1 (Testing Relay1)	Testing Relay 1 (on IB2 Board).	--
...	...	
Testing Relay8 (Testing Relay8)	Testing Relay 8 (on IB2 Board).	
EIB (Extended Interface Board) Alarms (EIB2 board must be present in system) (EIB)		
EIB Communication Fail (EIB Comm Fail)	EIB board has lost communications with the Controller.	Check communications cables.
Bad Battery Block (Bad Batt Block)	Battery block fails.	Check batteries.
Testing Relay9 (Testing Relay9)	Testing Relay 9 (on EIB Board).	--
...	...	
Testing Relay13 (Testing Relay13)	Testing Relay 13 (on EIB Board).	
SMDU 1 [2, 3, 4, 5, 6, 7, 8] Alarms (SM-DU Module must be present in system) (SMDU 1 [2, 3, 4, 5, 6, 7, 8])		
Under Voltage (Under Voltage)	Distribution voltage is below under voltage threshold.	Check to see why system voltage is low.
Over Voltage (Over Voltage)	Distribution voltage is above over voltage threshold.	Check to see why system voltage is low.
Communication Fail (Comm Fail)	The SM-DU 1 has lost communications with the Controller.	Check communications cables.

Table 4

Full Alarm Name - WEB (Abbreviated Alarm Name - LCD)	Alarm Description	Action to Correct
Current1 High Current (Curr 1 Hi)	Current 1 has high current.	Check why current is high.
Current1 Very High Current (Curr 1 Very Hi)	Current 1 has very high current.	
...	...	
...	...	
Current5 High Current (Curr 5 Hi)	Current 5 has high current.	
Current5 Very High Current (Curr 5 Very Hi)	Current 5 has very high current.	
Shunt1 Coefficient Conflict (Shunt1 Conflict)	Shunt 1 coefficient conflicting.	Verify shunt size.
...	...	
Shunt5 Coefficient Conflict (Shunt5 Conflict)	Shunt 4 coefficient conflicting.	
Converter Group Alarms (Converter Grp)		
Multiple Converters Failure (Multi-Conv Fail)	More than one converter has failed.	Check input voltage to converters. Replace converters.
Converter Lost (Converter Lost)	A converter cannot be detected by the Controller.	Reset the Converter Lost alarm. Replace defective converter.
All Converters Comm Fail (AllConvCommFail)	No response from all converters.	Check the connectors and cables or the CAN loop. Replace the Controller.
Over Current (Over Current)	Over current condition exists.	Check why.
Converter Alarms (Converter)		
Communication Fail (Comm Fail)	A converter has lost communications with the Controller.	Check communications cables. Reset the Communication Fail alarm. Replace the converter.
Over Temperature (Over Temp)	A converter has an over temperature condition.	Check why temperature is high.
HVSD Alarm (HVSD Alarm)	A converter has an overvoltage condition.	Refer to Converter User Manual for troubleshooting information.

Table 4

Full Alarm Name - WEB (Abbreviated Alarm Name - LCD)	Alarm Description	Action to Correct
Fan Failure (Fan Failure)	A converter's fan has failed.	Replace fan.
Power Limit (Power Limit)	A converter is in temperature power limit.	Converter overload. The load is higher than converter capacity.
Input Low Voltage (Input Low Volt)	Input voltage to a converter is low.	--
Converter Failure (Converter Fail)	A converter has a fault condition.	Refer to Converter User Manual for troubleshooting information.
EEPROM Fail (EEPROM Fail)	A converter's EEPROM has failed.	
Thermal Shutdown (Thermal SD)	A converter is in thermal shutdown.	
Mod ID Overlap (Mod ID Overlap)	Converter module ID's overlap.	--
Under Voltage (Under Voltage)	A converter has an under voltage condition.	--
Over Voltage (Over Voltage)	A converter has an over voltage condition.	--
SMIO 1 Generic Unit 1 Alarms (SM-IO Module must be present in system) (SMIO 1)		
SMIO Failure (SMIO Fail)	SMIO has failed.	--
SMIO Generic Unit 3 [4, 5, 6, 7, 8] Alarms (SM-IO Module must be present in system) (SMIO Unit 3 [4, 5, 6, 7, 8])		
High Analog Input 1 Alarm (Hi AI 1 Alarm)	Input #1 above high alarm threshold.	--
Low Analog Input 1 Alarm (Low AI 1 Alarm)	Input #1 below low alarm threshold.	--
...	...	
...	...	
High Analog Input 5 Alarm (Hi AI 5 Alarm)	Input #5 above high alarm threshold.	--
Low Analog Input 5 Alarm (Low AI 5 Alarm)	Input #5 below low alarm threshold.	--

Table 4

Full Alarm Name - WEB (Abbreviated Alarm Name - LCD)	Alarm Description	Action to Correct
High Frequency Input Alarm (Hi Freq In Alm)	Input frequency above high frequency alarm threshold.	--
Low Frequency Input Alarm (Low Freq In Alm)	Input frequency below low frequency alarm threshold.	--
SMIO Failure (SMIO Fail)	SM-IO board failure.	Replace the board.
Testing Relay 1 (Testing Relay 1)	Testing Relay 1.	--
Testing Relay 2 (Testing Relay 2)	Testing Relay 2.	
Testing Relay 3 (Testing Relay 3)	Testing Relay 3.	
LargeDU AC Distribution Group Alarms (Large Distribution Unit must be present in system) (LargeDUACDist)		
Mains Failure (Mains Failure)	Commercial AC power failure.	--
LargeDU AC Distribution Alarms (Large Distribution Unit must be present in system) (AC Distributi)		
Mains 1 Failure (Mains 1 Fail)	AC input 1 power failure.	--
Mains 2 Failure (Mains 2 Fail)	AC input 2 power failure.	--
Mains 3 Failure (Mains 3 Fail)	AC input 3 power failure.	--
Mains 1 Uab/Ua Failure (M1 Uab/Ua Fail)	No AC input voltage between Line A and Line B of input 1.	--
Mains 1 Ubc/Ub Failure (M1 Ubc/Ub Fail)	No AC input voltage between Line B and Line C of input 1.	--
Mains 1 Uca/Uc Failure (M1 Uca/Uc Fail)	No AC input voltage between Line C and Line A of input 1.	--
Mains 2 Uab/Ua Failure (M2 Uab/Ua Fail)	No AC input voltage between Line A and Line B of input 2.	--
Mains 2 Ubc/Ub Failure (M2 Ubc/Ub Fail)	No AC input voltage between Line B and Line C of input 2.	--
Mains 2 Uca/Uc Failure (M2 Uca/Uc Fail)	No AC input voltage between Line C and Line A of input 2.	--

Table 4

Full Alarm Name - WEB (Abbreviated Alarm Name - LCD)	Alarm Description	Action to Correct
Mains 3 Uab/Ua Failure (M3 Uab/Ua Fail)	No AC input voltage between Line A and Line B of input 3.	--
Mains 3 Ubc/Ub Failure (M3 Ubc/Ub Fail)	No AC input voltage between Line B and Line C of input 3.	--
Mains 3 Uca/Uc Failure (M3 Uca/Uc Fail)	No AC input voltage between Line C and Line A of input 3.	--
Over Frequency (Over Frequency)	Input frequency above over frequency alarm threshold.	--
Under Frequency (Under Frequency)	Input frequency below under frequency alarm threshold.	--
Mains 1 Uab/Ua Over Voltage (M1 Uab/Ua OverV)	AC input 1 voltage between Line A and Line B above over voltage threshold.	--
Mains 1 Ubc/Ub Over Voltage (M1 Ubc/Ub OverV)	AC input 1 voltage between Line B and Line C above over voltage threshold.	--
Mains 1 Uca/Uc Over Voltage (M1 Uca/Uc OverV)	AC input 1 voltage between Line C and Line A above over voltage threshold.	--
Mains 2 Uab/Ua Over Voltage (M2 Uab/Ua OverV)	AC input 2 voltage between Line A and Line B above over voltage threshold.	--
Mains 2 Ubc/Ub Over Voltage (M2 Ubc/Ub OverV)	AC input 2 voltage between Line B and Line C above over voltage threshold.	--
Mains 2 Uca/Uc Over Voltage (M2 Uca/Uc OverV)	AC input 2 voltage between Line C and Line A above over voltage threshold.	--
Mains 3 Uab/Ua Over Voltage (M3 Uab/Ua OverV)	AC input 3 voltage between Line A and Line B above over voltage threshold.	--
Mains 3 Ubc/Ub Over Voltage (M3 Ubc/Ub OverV)	AC input 3 voltage between Line B and Line C above over voltage threshold.	--
Mains 3 Uca/Uc Over Voltage (M3 Uca/Uc OverV)	AC input 3 voltage between Line C and Line A above over voltage threshold.	--

Table 4

Full Alarm Name - WEB (Abbreviated Alarm Name - LCD)	Alarm Description	Action to Correct
Mains 1Uab/Ua Under Voltage (M1Uab/Ua UnderV)	AC input 1 voltage between Line A and Line B below under voltage threshold.	--
Mains 1Ubc/Ub Under Voltage (M1Ubc/Ub UnderV)	AC input 1 voltage between Line B and Line C below under voltage threshold.	--
Mains 1Uca/Uc Under Voltage (M1Uca/Uc UnderV)	AC input 1 voltage between Line C and Line A below under voltage threshold.	--
Mains 2Uab/Ua Under Voltage (M2Uab/Ua UnderV)	AC input 2 voltage between Line A and Line B below under voltage threshold.	--
Mains 2Ubc/Ub Under Voltage (M2Ubc/Ub UnderV)	AC input 2 voltage between Line B and Line C below under voltage threshold.	--
Mains 2Uca/Uc Under Voltage (M2Uca/Uc UnderV)	AC input 2 voltage between Line C and Line A below under voltage threshold.	--
Mains 3Uab/Ua Under Voltage (M3Uab/Ua UnderV)	AC input 3 voltage between Line A and Line B below under voltage threshold.	--
Mains 3Ubc/Ub Under Voltage (M3Ubc/Ub UnderV)	AC input 3 voltage between Line B and Line C below under voltage threshold.	--
Mains 3Uca/Uc Under Voltage (M3Uca/Uc UnderV)	AC input 3 voltage between Line C and Line A below under voltage threshold.	--
AC Input MCCB Trip (Input MCCB Trip)	Main input circuit breaker open.	--
AC Output MCCB Trip (OutputMCCB Trip)	Main output circuit breaker open.	--
SPD Trip (SPD Trip)	Surge protection device tripped.	--
Communication Fail (Comm Fail)	AC distribution monitoring device has lost communications with the Controller.	Check communications cables.

Table 4

Full Alarm Name - WEB (Abbreviated Alarm Name - LCD)	Alarm Description	Action to Correct
LargeDU DC Distribution Alarms (Large Distribution Unit must be present in system) (DC Distributi)		
DC Over Voltage (DC Over Volt)	DC output voltage above over voltage threshold.	--
DC Under Voltage (DC Under Volt)	DC output voltage below under voltage threshold.	--
DC Output 1 Disconnected (Output1 Discon)	Output #1 distribution device open.	--
...	...	
DC Output 64 Disconnected (Output64 Discon)	Output #64 distribution device open.	--
Communication Fail (Comm Fail)	DC distribution monitoring device has lost communications with the Controller.	Check communications cables.
Temperature 1 Over Temperature (T1 Over Temp)	Temperature sensor #1 sensing temperature higher than over temperature threshold.	--
Temperature 2 Over Temperature (T2 Over Temp)	Temperature sensor #2 sensing temperature higher than over temperature threshold.	--
Temperature 3 Over Temperature (T3 Over Temp)	Temperature sensor #3 sensing temperature higher than over temperature threshold.	--
Temperature 1 Under Temperature (T1 Under Temp)	Temperature sensor #1 sensing temperature lower than under temperature threshold.	--
Temperature 2 Under Temperature (T2 Under Temp)	Temperature sensor #2 sensing temperature lower than under temperature threshold.	--
Temperature 3 Under Temperature (T3 Under Temp)	Temperature sensor #3 sensing temperature lower than under temperature threshold.	--
Temperature 1 Sensor Failure (T1 Sensor Fail)	Temperature sensor #1 failure.	--
Temperature 2 Sensor Failure (T2 Sensor Fail)	Temperature sensor #2 failure.	--

Table 4

Full Alarm Name - WEB (Abbreviated Alarm Name - LCD)	Alarm Description	Action to Correct
Temperature 3 Sensor Failure (T3 Sensor Fail)	Temperature sensor #3 failure.	--
Diesel Generator Group Alarms (Dsl Gen Group)		
Diesel Generator Test Running (Test Running)	Diesel test in progress.	--
Diesel Generator Test Failure (Test Failure)	Diesel test failed.	--
Diesel Generator Alarms (Dsl Generator)		
Low DC Voltage (Low DC Voltage)	Generator has low DC voltage.	--
Diesel Generator Supervision Fail (SupervisionFail)	Generator monitoring device has failed.	--
Diesel Generator Failure (Diesel Fail)	Generator has failed.	--
Diesel Generator Connected (Diesel Connect)	Generator is connected to the system.	--
Low Fuel Level (Low Fuel Level)	Generator has low fuel level.	--
High Water Temperature (High Water Temp)	Generator has high water temperature.	--
Low Oil Pressure (Low Oil Press)	Generator has low oil pressure.	--
Rectifier Group 2 [3, 4] Alarms (Rect Group 2 [3, 4])		
All Rectifiers Comm Fail (AllRectCommFail)	No response from all rectifiers.	Check the connectors and cables or the CAN loop. Replace the Controller.
Rectifier Lost (Rectifier Lost)	A rectifier cannot be detected by the Controller.	Reset the Rectifier Lost alarm. Replace defective rectifier.
Comm Failure (Comm Failure)	A rectifier has lost communications with the Controller.	Reset the Comm Fail alarm. Replace defective rectifier.
Mains Failure (Mains Failure)	Rectifier commercial AC input power failure.	--

Table 4

Full Alarm Name - WEB (Abbreviated Alarm Name - LCD)	Alarm Description	Action to Correct
Group 2 [3, 4] Rectifier Alarms (Group 2 [3, 4] Rect)		
AC Input Failure (AC Failure)	No AC input power to a rectifier.	Check why no AC input power available.
Rect Temperature High (Rect Temp High)	A rectifier has a high temperature condition.	Check why temperature is high.
Rectifier Fault (Rect Fault)	A rectifier has a fault condition.	Refer to Rectifier User Manual for troubleshooting information.
Over Voltage (Over Voltage)	A rectifier has an over voltage condition.	
Rectifier Protected (Rect Protected)	A rectifier is in protected mode.	
Fan Failure (Fan Failure)	A rectifier's fan has failed.	Replace fan.
Current Limit (Current Limit)	A rectifier is in current limit.	Rectifier overload. The load is higher than rectifier capacity. If the batteries are being recharged, the alarm will cease by itself when the battery voltage has increased to the charging level. If the system load is higher than the rectifier capacity, the batteries will discharge. If this is the reason, install additional rectifiers. If one or more of the rectifiers are defective, replace the faulty rectifiers.
Rectifier Communication Fail (Rect Comm Fail)	A rectifier has lost communications with the Controller.	Check communications cables. Reset the Communication Fail alarm. Replace the rectifier.
Derated (Derated)	A rectifier is in output power derating mode.	Refer to Rectifier User Manual for troubleshooting information.
Current Share Alarm (CurrShare Alarm)	A rectifier has a current sharing alarm.	
Low AC Voltage Protection (Low AC Protect)	A rectifier is in under voltage protection mode.	
SMDUP Alarms (SM-DU+ Module must be present in system) (SMDUP)		
Communication Fail (Comm Fail)	Communications failure.	Check communications cables.

Table 4

Full Alarm Name - WEB (Abbreviated Alarm Name - LCD)	Alarm Description	Action to Correct
Current1 High Current (Curr 1 Hi)	Current 1 high.	--
Current1 Very High Current (Curr 1 Very Hi)	Current 1 very high.	--
...	...	--
...	...	--
Current25 High Current (Curr 25 Hi)	Current 25 high.	--
Current25 Very High Current (Curr 25 Very Hi)	Current 25 very high.	--
SMBRC Unit Alarms (SM-BRC Module must be present in system) (SMBRC Unit)		
Communication Fail (Comm Fail)	Communications failure.	Check communications cables.
Ambient High Temperature (Amb Temp High)	Ambient high temperature alarm.	--
Ambient Low Temperature (Amb Temp Low)	Ambient low temperature alarm.	--
Ambt Temp Not Used (Amb Temp No Use)	No ambient temperature sensor.	--
Fuel Tank Group Alarms (Fuel Tank Grp)		
Fuel Group Communication Failure (Fuel Comm Fail)	Fuel tank group communication failure.	Check communications cables.
Fuel Tank Alarms (Fuel Tank)		
High Fuel Level Alarm (Hi Level Alarm)	Fuel tank high level alarm.	--
Low Fuel Level Alarm (Low Level Alarm)	Fuel tank low level alarm.	--
Fuel Theft Alarm (Fuel Theft Alm)	Fuel tank theft alarm.	--
Tank Height Error (Tank Height Err)	Fuel tank height error.	--

Table 4

Full Alarm Name - WEB (Abbreviated Alarm Name - LCD)	Alarm Description	Action to Correct
Fuel Tank Config Error (Fuel Config Err)	Fuel tank configuration error.	--
SM Temp Group (SM-Temp Module must be present in system) (SM Temp Group)		
SM Temp Lost (SMTemp Lost)	SM-Temp cannot be detected by the Controller.	Reset the SMTemp Lost alarm. Replace defective SM-Temp.
SM Temp 1-8 (SM-Temp Module must be present in system) (SMTemp 1-8)		
Communication Interrupt (Comm Interrupt)	SM-Temp has lost communications with the Controller.	Check communications cables.
Temperature Probe 1 Shorted (Probe1 Short)	Probe shorted.	Replace temperature probe.
...	...	
Temperature Probe 8 Shorted (Probe8 Short)	Probe shorted.	
Temperature Probe 1 Open (Probe1 Open)	Probe open.	Replace temperature probe.
...	...	
Temperature Probe 8 Open (Probe8 Open)	Probe open.	

Table 4
Available Alarms

2.7 Power Split Feature

In Power Split applications, the output of the power system controlled by the ACU+ can be connected in parallel with an existing power system. Each system is controlled independently via its own Controller. The ACU+ power system is referred to as the "slave" system and the existing power system as the "master" system. The Power Split feature controls the ACU+ power system's output voltage and rectifiers' current limit so that the "slave" power system shares the load with the "master" system.

Optional Functions: The ACU+ Controller can mimic the equalize and battery test functions of the "master" system's Controller. In addition, the ACU+ Controller can mimic the low voltage load disconnect and/or low voltage battery disconnect functions of the "master" system. This is accomplished by supplying digital signals from the "master" system's Controller to the ACU+. This allows these functions to remain active in the "master" system.

2.7.1 Overview

See "1.3.7 Power Split Feature".

2.7.2 How Power Split Works

There are four User adjustable parameters for Power Split. They are:

- **Slave Curr Lmt:** Current limit point for power system designated as the slave system in a "Power Split" configuration.
- **Delta Volt:** The offset voltage that the power system designated as the slave system in a "Power Split" configuration is set to. It is suggested to leave this value at the default (0.5 volts).
- **Proportion Coeff:** The proportional coefficient that the power system designated as the slave system in a "Power Split" configuration is set to. It is suggested to leave this value at the default (30%).
- **Integral Time:** The integral time that the power system designated as the slave system in a "Power Split" configuration is set to. It is suggested to leave this value at the default (60 seconds).

The ACU+ Controller uses these parameters to control the load sharing operation between the two power systems.

Depending on the systems' configurations, their rectifier capacities, their distribution load capacities, and the Power Split configuration; four operating modes can occur.

Low Load Operation

When the total load current demand is lower than the SLAVE CURRENT LIMIT value, the ACU+ power system voltage will be increased by the programmed DELTA VOLTAGE setting forcing the ACU+ power system to carry the load. Make sure that the output voltage does not exceed the battery float range recommended by the manufacturer. In this operating mode, no current will be delivered by the existing power system.

Normal Load Operation

When the total load current demand reaches the SLAVE CURRENT LIMIT value, the ACU+ power system operates in output current limit and its output voltage will be decreased (up to the DELTA VOLTAGE setting) in order to regulate the current, allowing the existing power system to deliver the remaining current. Both the ACU+ power system and the existing power system are now providing current to the load.

High Load Operation

If current demand increases and the existing power system reaches its current limit setting, float voltage will again begin to decrease. When the voltage falls below the float setting minus the DELTA VOLTAGE setting, the ACU+ system will come out of current limit and now deliver the additional current necessary to satisfy the load. This operation may occur when the batteries are being recharged, such as after a commercial AC failure.

Over Load Operation

If the load current is greater than the combined current capacities of the ACU+ system and the existing power system, both power systems will go into current limit. Both systems and the batteries will feed the load. The output voltage will depend on the conditions of the batteries. This operation occurs if the total capacity of the rectifiers is too low in relation to the need for increased current.

2.7.3 Operating Modes

Figure 5 illustrates the four modes of operation described above.

The Normal Load Operation is considered to be the normal mode. In this mode both the ACU+ system and the existing parallel power system are both delivering load current. This is main purpose of using Power Split, to avoid putting the burden of delivering the entire load onto one of the two power systems.

2.7.4 Requirements and Conditions

The two DC power systems must be connected in parallel as described in “2.7.5. *Paralleling the Existing and ACU+ Power Systems*”.

Before paralleling the two systems, the following conditions must be met for proper Power Split function.

Note: *The control features of the combined system are limited to those of the original power system.*

Note: *The same type of batteries with an equal amount of cells and the same charging voltages must be used for both systems.*

- The float voltage, equalize voltage, and battery test voltage of the ACU+ power system must be set to the same levels as that of the existing power system.
- The remote sense, if available and connected, of both the ACU+ power system and existing power system must be connected to the same point.
- If batteries are used, they must be of the same type.
- All the functions specific to the existing power system and ACU+ power system and which depend on the voltage or which act on the voltage must be disabled from the existing power system and ACU+ power system. This includes the following...
 - any equalization function,
 - any temperature compensation function,
 - any charge control function,
 - any battery discharge test function, and
 - any invalid current alarm.

In lieu of this, if battery charging and battery test functions are implemented in the existing power system, they can remain if signals for starting are connected from the control system of the existing system to the ACU+ system.

2.7.5 Paralleling the Existing and ACU+ Power Systems

Admonishments

General Safety

Danger: *YOU MUST FOLLOW APPROVED SAFETY PROCEDURES.*

Performing the following procedures may expose you to hazards. These procedures should be performed by qualified technicians familiar with the hazards associated with this type of equipment. These hazards may include shock, energy, and/or burns. To avoid these hazards:

- a) The tasks should be performed in the order indicated.*
- b) Remove watches, rings, and other jewelry.*
- c) Prior to contacting any uninsulated surface or termination, use a voltmeter to verify that no voltage or the expected voltage is present.*
- d) Wear eye protection, and use recommended tools.*
- e) Use double insulated tools appropriately rated for the work to be performed.*

AC Input Voltages

Danger: *This system operates from AC voltage capable of producing fatal electrical shock.*

DC Input/Output Voltages

Danger: *Connecting the ACU+ power system to an existing power system for “Power Split” mode involves working on live equipment carrying live loads. This system produces DC power and may require battery to be connected to it. Although the DC voltage is not hazardously high, the rectifiers and/or battery can deliver large amounts of current. Exercise extreme caution not to inadvertently contact or have any tool inadvertently contact a battery terminal or exposed wire connected to a battery terminal. NEVER allow a metal object, such as a tool, to contact more than one termination at a time, or to simultaneously contact a termination and a grounded object. Even a momentary short circuit can cause explosion and injury. Remove watches, rings, or other jewelry before connecting leads. Cover any live busbars with a canvas sheet to prevent short circuits caused by falling tools or parts.*

Preparing the Existing and ACU+ Power Systems

- Install and turn-up the ACU+ power system as describe in the installation instructions furnished with the power system.
- Set the float voltage on both the existing and ACU+ power systems to the same level. Temperature compensation functionality, if used, should be disabled on both power systems.

Paralleling the Systems

- Connect the Battery and Battery Return busbars of the ACU+ Power System to the main charge busbars (rectifier side of the shunt) on the parallel power system. Size the cable for the largest current between systems.

Note 1: *The connections between the two power systems should be done with power cables appropriately sized to be capable of carrying the maximum current that can circulate between the two power systems.*

- Note 2:** *If the parallel power system incorporates a main plant shunt, the connections of the cables from the ACU+ power system to the parallel power system shall be made on the main charge busbars (rectifier side of the shunt).*
- Note 3:** *To compensate for voltage drop, it is recommended to connect the ACU+ power system's remote sense leads (if available) to the same point of sensing as the parallel power system.*
- Note 4:** *There shall be only one battery return reference (BRR) cable for the two power systems. If the cable is appropriately sized on the parallel power system, keep it as the BRR for both power systems. If the cable is not appropriately sized on the parallel power system, install a new BRR cable and connect it preferably to the ACU+ power system since the parallel power system may eventually be phased out.*
- Note 5:** *If battery disconnect units (BDUs) are used on the new or parallel power system, these shall be wired in such a way as to be all triggered simultaneously in order to prevent any overloading of these.*
- Note 6:** *For the size and number of bridge cables between the two power systems, take into consideration the voltage drop, the available connecting points in each system, as well as the fact that these cables are unfused and shall therefore be run on a dedicated cable rack. "C" or "H" taps may be used to make full use of available connecting points.*
- Note 7:** *The legacy system retains the function of its controller and the percent of load on each plant is controlled by the ACU+. Alarms may be sent individually from each plant, or combined using an ACU+ Interface Board and the programmable relays resident in the controller.*
- Note 8:** *Add a label on both power systems to indicate that these are operating in the Power Split Mode with each other.*
- **Optional Function Connections:** The following signals from the existing system must be connected to digital inputs of the ACU+ system interface board for these functions to be active: Equalize Charge in Progress, Battery Test in Progress, Load LVD Active, and Battery LVD Active. Otherwise disable these functions.

2.7.6 Programming the ACU+ Power Split Feature

After an ACU+ power system has been connected to an existing power system and both systems set for the same float voltage, you will have to configure the Power Split parameters in the ACU+.

Procedure

- 1) Set the Power Split mode to slave. Navigate to Main Menu / Settings / Power System / General / Contactor Mode. Set this parameter to "Slave Control".
- 2) Reboot the ACU+ by pressing ESC and ENT at the same time.
- 3) Navigate to Main Menu / Settings / Power System / Power Split.
- 4) Navigate to and set the "Slave Current Limit" to a value that will force the ACU+ system's rectifiers to operate in current limiting mode.

Note: *The Slave Current Limit must be set lower than the total distribution current from the two plants. The default value is 60% of the ACU+ power system's rectifier capacity.*

- 5) Navigate to and set the "Delta Voltage". This voltage is by default set to 0.5V but can be readjusted.
 - If the distribution current is lower than 50% of the total capacity of the ACU+ power system, the "Delta Voltage" can be adjusted to a lower level than 0.5V to get a system voltage that is closer to the desired float charging voltage.
 - If the voltage drop between the existing system and the ACU+ system is expected to be >0.5V, the "Delta Voltage" can be adjusted to a higher level than 0.5 V to get a correct split function.
 - Temperature controlled battery charging cannot be set in the ACU+ power system in power split mode. If this function is implemented in the existing power system, a limited function within a temperature range of approximately $\pm 15^{\circ}\text{C}$ will be achieved if the Delta Voltage is set to a higher level, maximum 2.00V.
 - If the "Delta Voltage" 0.5V is considered to be too high, the split function can be tested at various modes of operation to find a lower setting.

Optional Function Setup

Equalize Charge Setup

If the equalize charge function is to be used, equalize charge must be implemented in the existing power system and an equalizing signal from its control unit must be connected to the ACU+.

- 1) Navigate to Main Menu / Settings / Battery / Charge / EQ Voltage. Set the "EQ Voltage" to the same value as the equalize voltage of the existing power system.
- 2) Using the Web Interface (Maintenance / Edit PowerSplit), select the ACU+ digital input connected to the existing systems equalize control circuit.

Note: *Equalize charging is controlled by the existing power system via an incoming digital signal. The system will remain at the set equalize charge voltage level as long as this signal is active.*

Battery Test Setup

If the battery test function is to be used, battery test must be implemented in the existing power system and a test signal from its control unit must be connected to the ACU+.

- 1) Navigate to Main Menu / Settings / Battery / Test.
- 2) Navigate to and set the "Test End Volt" to the same value as the end voltage of the existing power system.

- 3) Navigate to and set the “Test Volt Lmt” to the same value as the test voltage of the existing power system.
- 4) Using the Web Interface (Maintenance / Edit PowerSplit), select the ACU+ digital input connected to the existing systems battery test control circuit.

Note: Other settings in this menu regarding “Battery Test” are inactive.

Note: Battery test is controlled by the existing power system via an incoming digital signal. The system will remain at battery test as long as this signal is active.

Low Voltage Disconnect Setup

If low voltage disconnect functions are to be used, they must be implemented in the existing power system and signals from its control unit must be connected to the ACU+.

- 1) Using the Web Interface (Maintenance / Edit PowerSplit), select the ACU+ digital inputs connected to the low voltage disconnect control circuits.

Temperature Compensated Battery Charge

There is no possibility to activate the “Temperature Compensated Battery Charge” function when the ACU+ power system is configured for “Power Split” mode.

However, the possibility to change the “Delta Voltage” enables the ACU+ power system to follow the existing power system that has the functionality to a certain limit.

Example: The “Delta Voltage” in the ACU+ power system is set to 1.0V. The existing power system is set to compensate 3.0 mV/cell/°C. This means that the ACU+ power system can follow the temperature compensation of the existing power system in the range of ±14°C from the set normal battery temperature (3.0 mV x 24 cells x 14°C = 1.008 V).

2.7.7 Verifying the Operation of the Power Split Feature

After programming the “Power Split” feature, verify its operation as follows.

- a) In a Power Split application where the ACU+ power system is taking all of the load and the rectifiers in the existing power system are all in the standby mode, use an external dry load bank of sufficient capacity to increase the load on the ACU+ power system over the “SLAVE CURRENT LIMIT” value.
 - 1) Verify that the ACU+ power system limits the total output of its rectifiers to the current equivalent to this programmed percentage.
 - 2) Verify that the ACU+ power system lowers its output voltage by the value of the programmed “DELTA VOLTAGE”.
 - 3) Verify that the rectifiers in the existing power system take the additional load as the load increases pass the “SLAVE CURRENT LIMIT” value.
 - 4) Further increase the load in order to exceed the total capacity of the rectifiers in the existing power system (or shut down some of the rectifiers in the existing power system if the capacity of the external dry load bank is not sufficient). Verify that the ACU+ power system starts taking the additional load as soon as the total capacity of the rectifiers in the existing power system is exceeded.
- b) In a Power Split application where the ACU+ power system is taking only part of the load (operating continuously at the current level equivalent to the programmed “SLAVE CURRENT LIMIT” percentage) and the rectifiers in the existing power system are taking the rest of the load, use an external dry load bank of sufficient capacity to increase the load in order to exceed the total capacity of the rectifiers in the existing power system (or shut down some of the rectifiers in the existing power system if the capacity of the external dry load bank is not sufficient).
 - 1) Verify that the ACU+ power system starts taking the additional load as soon as the total capacity of the rectifiers in the existing power system is exceeded.

CHAPTER 3. LOCAL DISPLAY MENUS

3.1 Overview

This section provides descriptions of the Local Display Menus. Refer also to “2.2 Passwords and Access Levels” and “3.3 Description of Local Display (and Web Interface) Menu Line Items”. For WEB interface, refer to “Chapter 4. WEB Interface Menus”.

3.2 Menus

Figure 8 provides flow diagrams of the menus accessed via the ACU+ Controller local display and keypad.

Note: *These instructions describe the complete functionality of the ACU+. Some functionality is dependent on hardware connected to the ACU+. Some menu items shown may not be present in the ACU+ used in your system.*

3.2.1 Adjustment Range Restrictions

Float Voltage Setting

- Cannot be adjusted higher than “EQ Voltage” setting.
- Cannot be adjusted lower than 1V (24V systems) or 2V (48V systems) above “Under Voltage 1 Alarm” setting or higher than 1V (24V systems) or 2V (48V systems) below “Over Voltage 1 Alarm” setting.

EQ Voltage Setting

- Cannot be adjusted lower than “Float Voltage” setting.

HVDS Limit

- Cannot be adjusted lower than 0.5V above the “EQ Voltage” setting.

Under Voltage 1 Alarm Setting

- Cannot be adjusted lower than “Under Voltage 2 Alarm” setting.
- Cannot be adjusted higher than “Over Voltage 1 Alarm” setting.

Under Voltage 2 Alarm Setting

- Cannot be adjusted higher than “Under Voltage 1 Alarm” setting.

Over Voltage 1 Alarm Setting

- Cannot be adjusted higher than “Over Voltage 2 Alarm” setting.
- Cannot be adjusted lower than “Under Voltage 1 Alarm” setting.

Over Voltage 2 Alarm Setting

- Cannot be adjusted lower than “Over Voltage 1 Alarm” setting.

LVD1 and LVD2 Disconnect Setting

- Cannot be adjusted higher than “LVD Reconnect Voltage” setting.

LVD1 and LVD2 Reconnect Setting

- Cannot be adjusted lower than “LVD Disconnect Voltage” setting.

INFO SCREENS

(Returns to MAIN SCREEN after a preset time period.)

Dev Name M820D
Serial No. 210244
02532
SW Ver 3.00

HW Ver 002
MAC Addr 00:89:
F5:02:2A:34
File Sys

Config Ver
Default

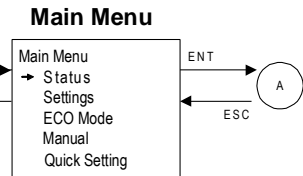
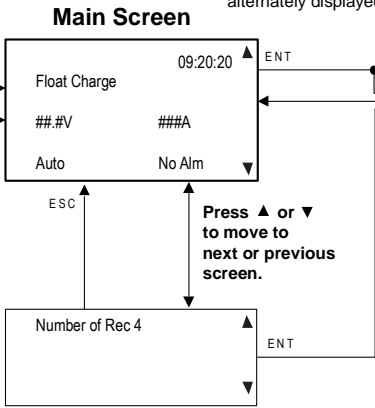

In the MAIN SCREEN:
Press ENT and ▲, or ENT and ▼ at the same time to change the contrast of the LCD.
Press ▲, ▼, and ESC at the same time to log out.
Press ENT and ESC at the same time to reset the ACU+ Controller.

Note: Certain line items in menu or menus themselves appear if system is equipped with function or function is enabled.

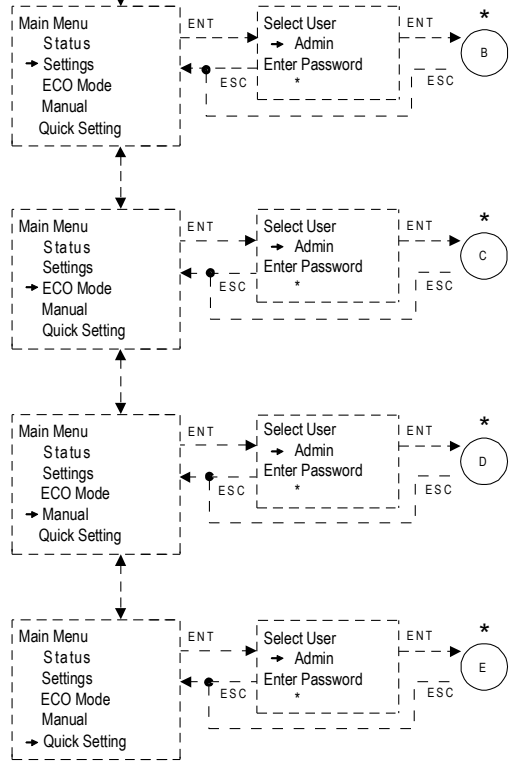

Local and Remote Access Passwords (set via the Web Interface)
Maximum 13 Characters (0-9, a-z, A-Z, _)

Access Level	Default Password	Authority
Level A (Browser)	none set	Browse System Information.
Level B (Operator)	none set	Change System Control Settings.
Level C (Engineer)	none set	Modify System Parameters. Download Configuration File.
Level D (Administrator)	1	Update OS Application. Modify, Add, Delete User Information.

Once a password is entered, it remains in effect for a preset time period to allow navigating between menus without re-entering the password.

A User has access to his/her level menus, plus all menus of the lesser access levels.

Figure 8 (cont'd on next page)
Local Menu Flow Diagrams

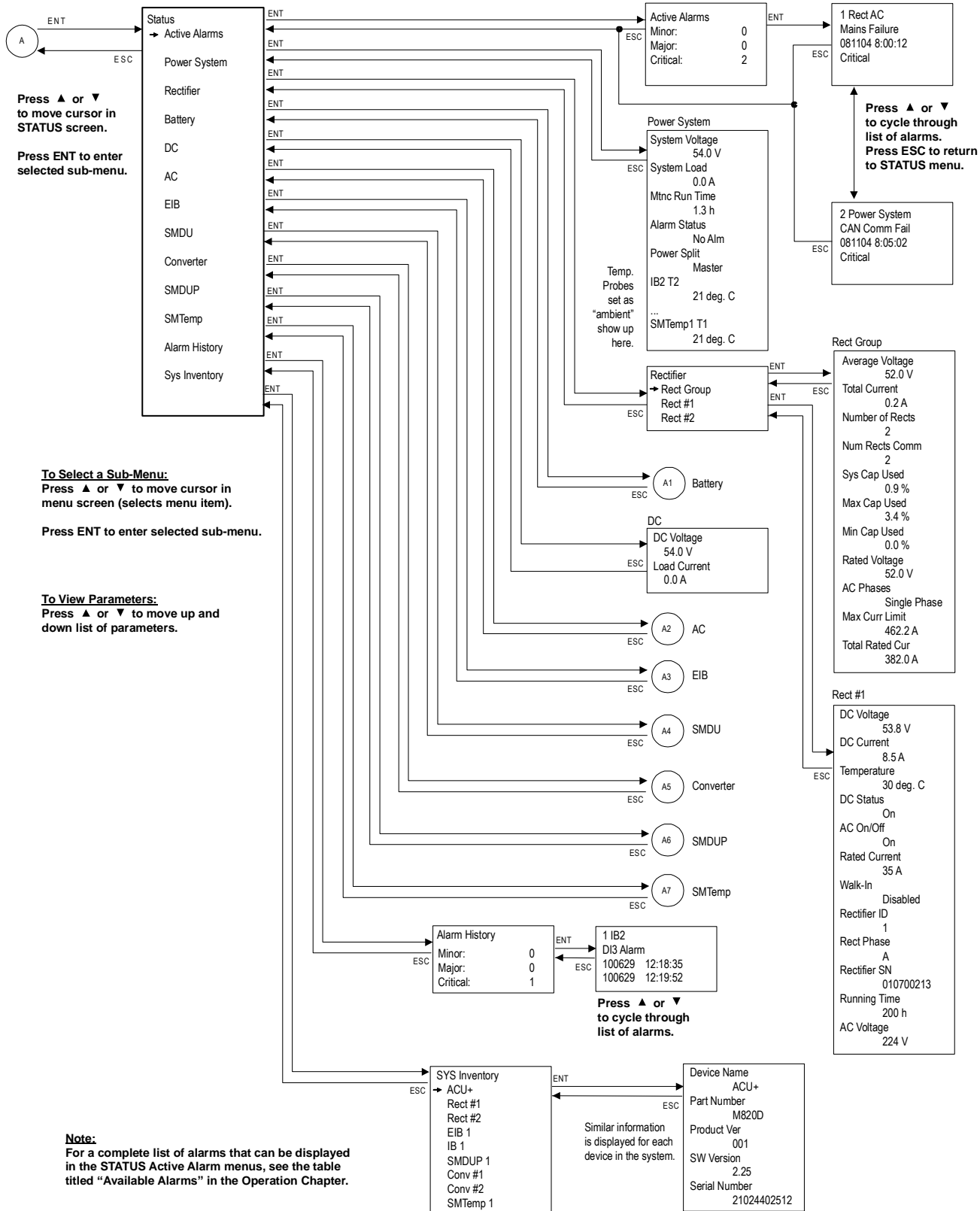

Figure 8 (cont'd from previous page, cont'd on next page)
 Local Menu Flow Diagrams

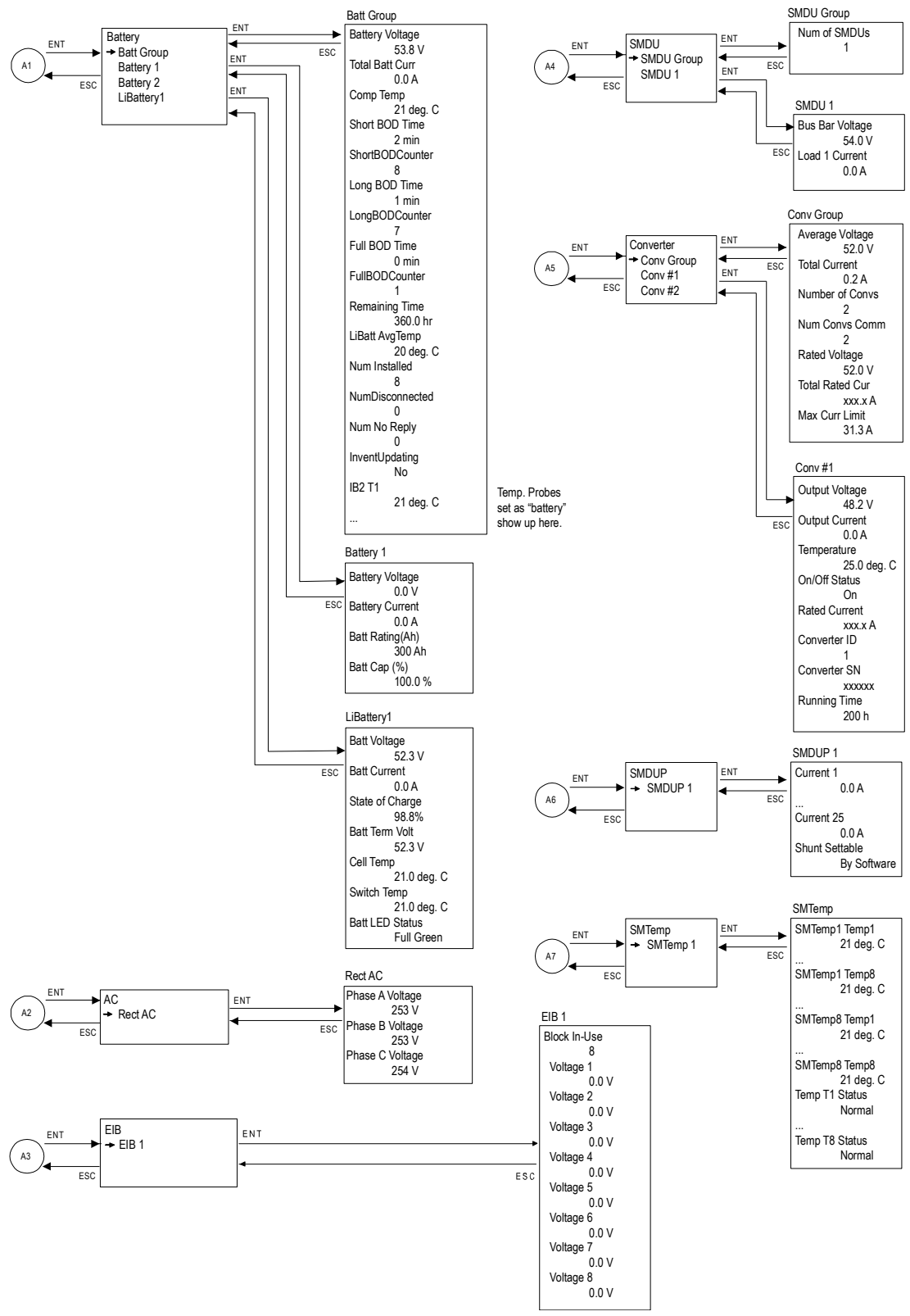

Figure 8 (cont'd from previous page, cont'd on next page)
Local Menu Flow Diagrams

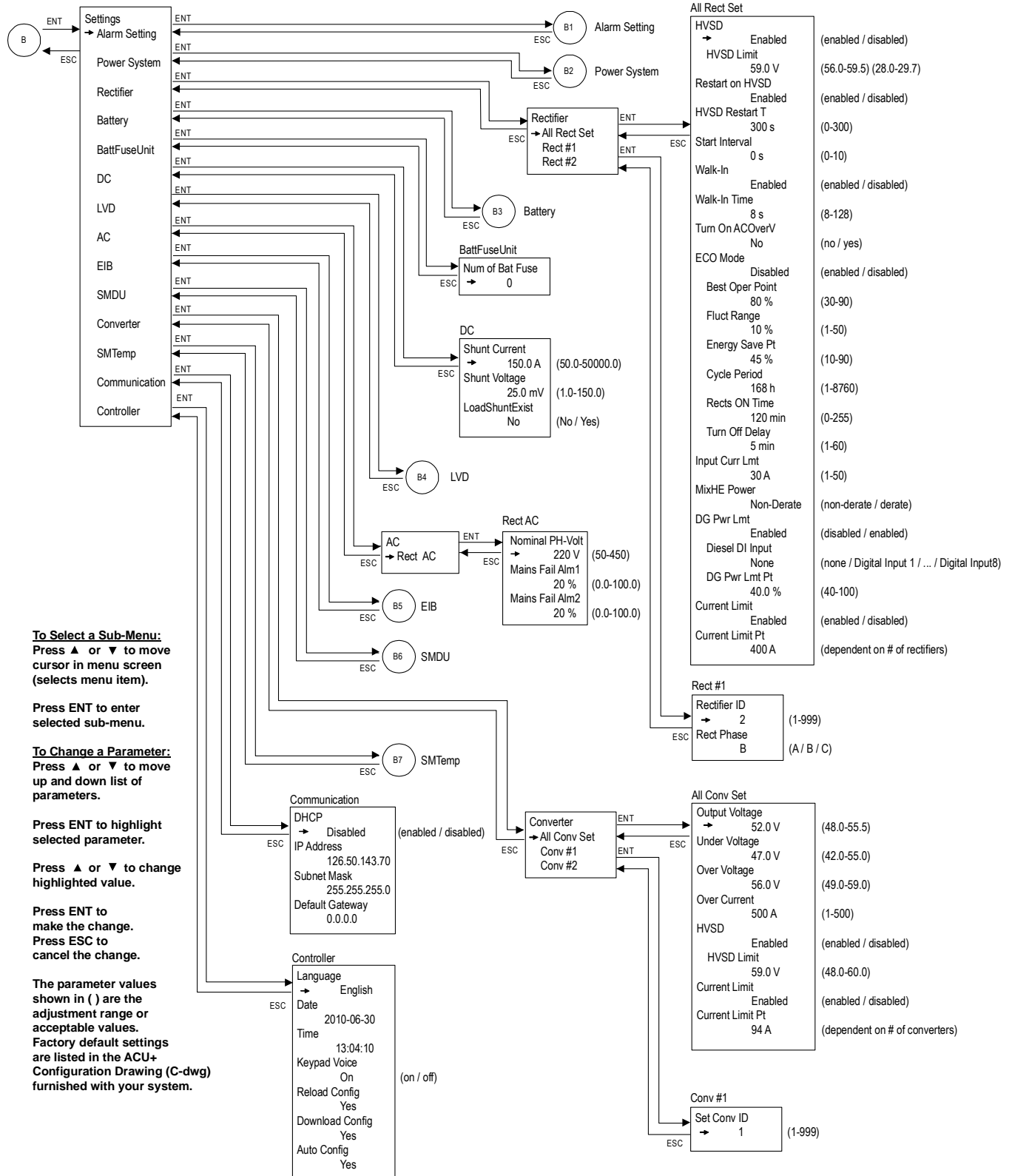
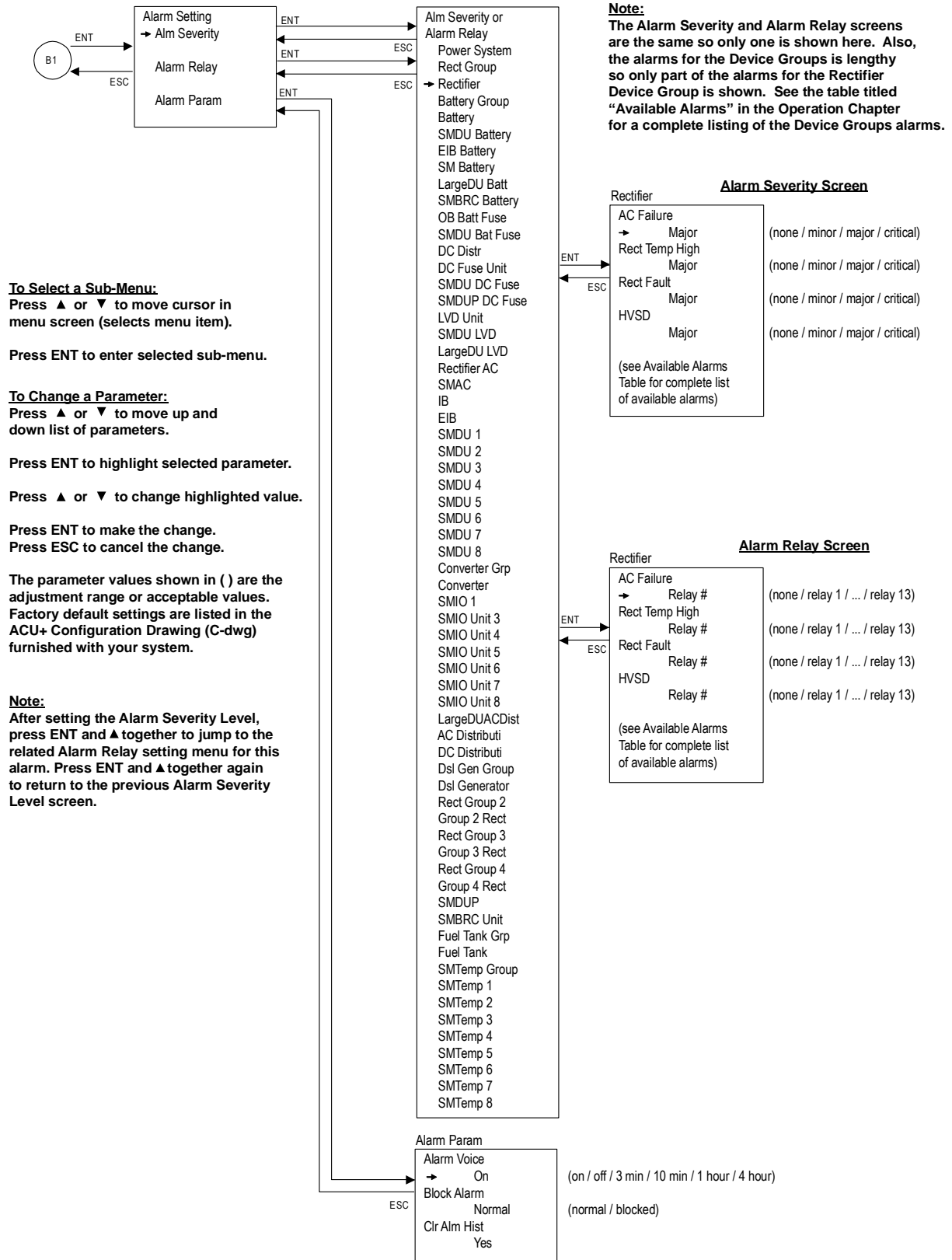

Figure 8 (cont'd from previous page, cont'd on next page)
 Local Menu Flow Diagrams



To Select a Sub-Menu:
Press ▲ or ▼ to move cursor in menu screen (selects menu item).
Press ENT to enter selected sub-menu.

To Change a Parameter:
Press ▲ or ▼ to move up and down list of parameters.
Press ENT to highlight selected parameter.
Press ▲ or ▼ to change highlighted value.
Press ENT to make the change.
Press ESC to cancel the change.

The parameter values shown in () are the adjustment range or acceptable values. Factory default settings are listed in the ACU+ Configuration Drawing (C-dwg) furnished with your system.

Note:
After setting the Alarm Severity Level, press ENT and ▲ together to jump to the related Alarm Relay setting menu for this alarm. Press ENT and ▲ together again to return to the previous Alarm Severity Level screen.

Figure 8 (cont'd from previous page, cont'd on next page)
Local Menu Flow Diagrams

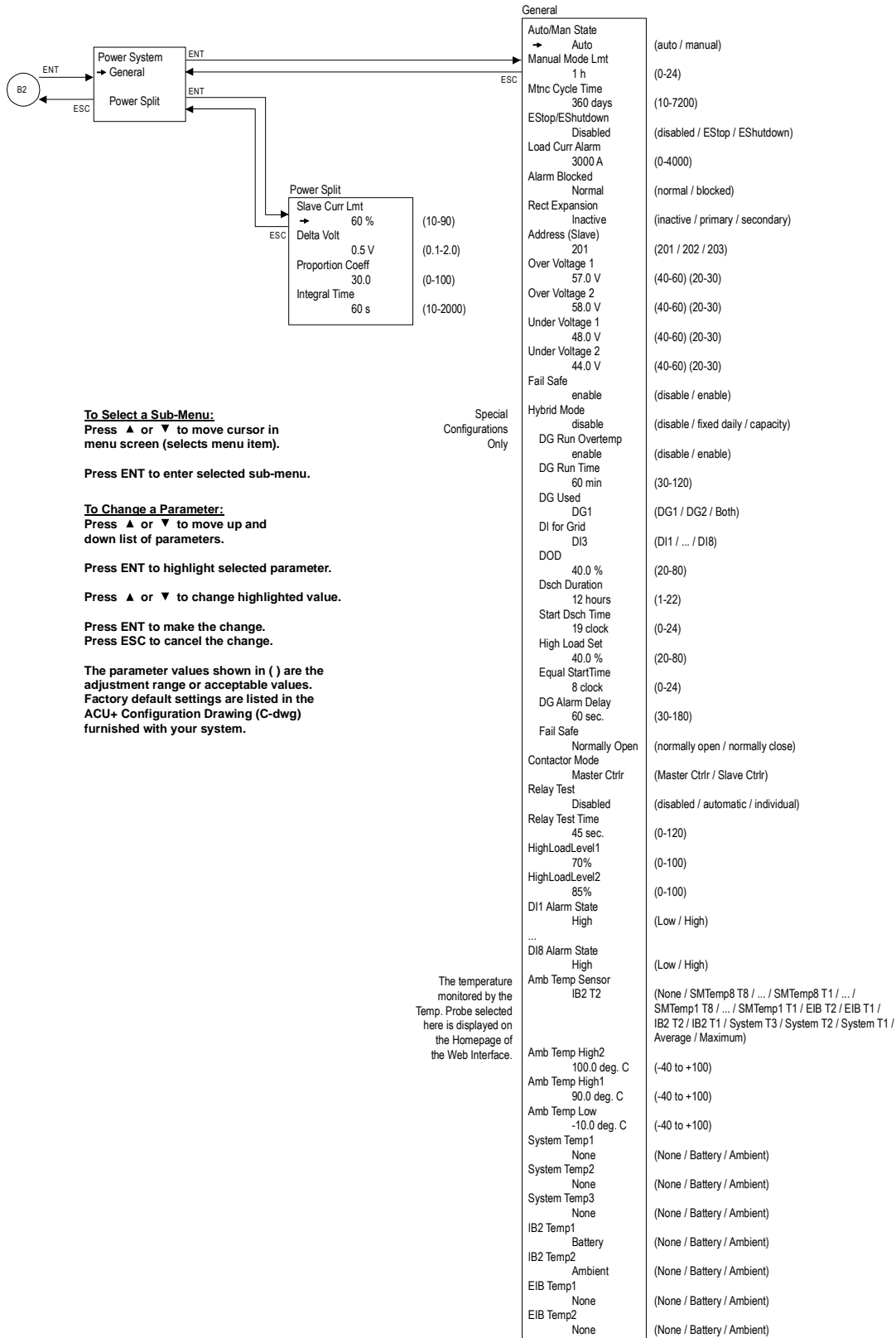

Figure 8 (cont'd from previous page, cont'd on next page)
 Local Menu Flow Diagrams

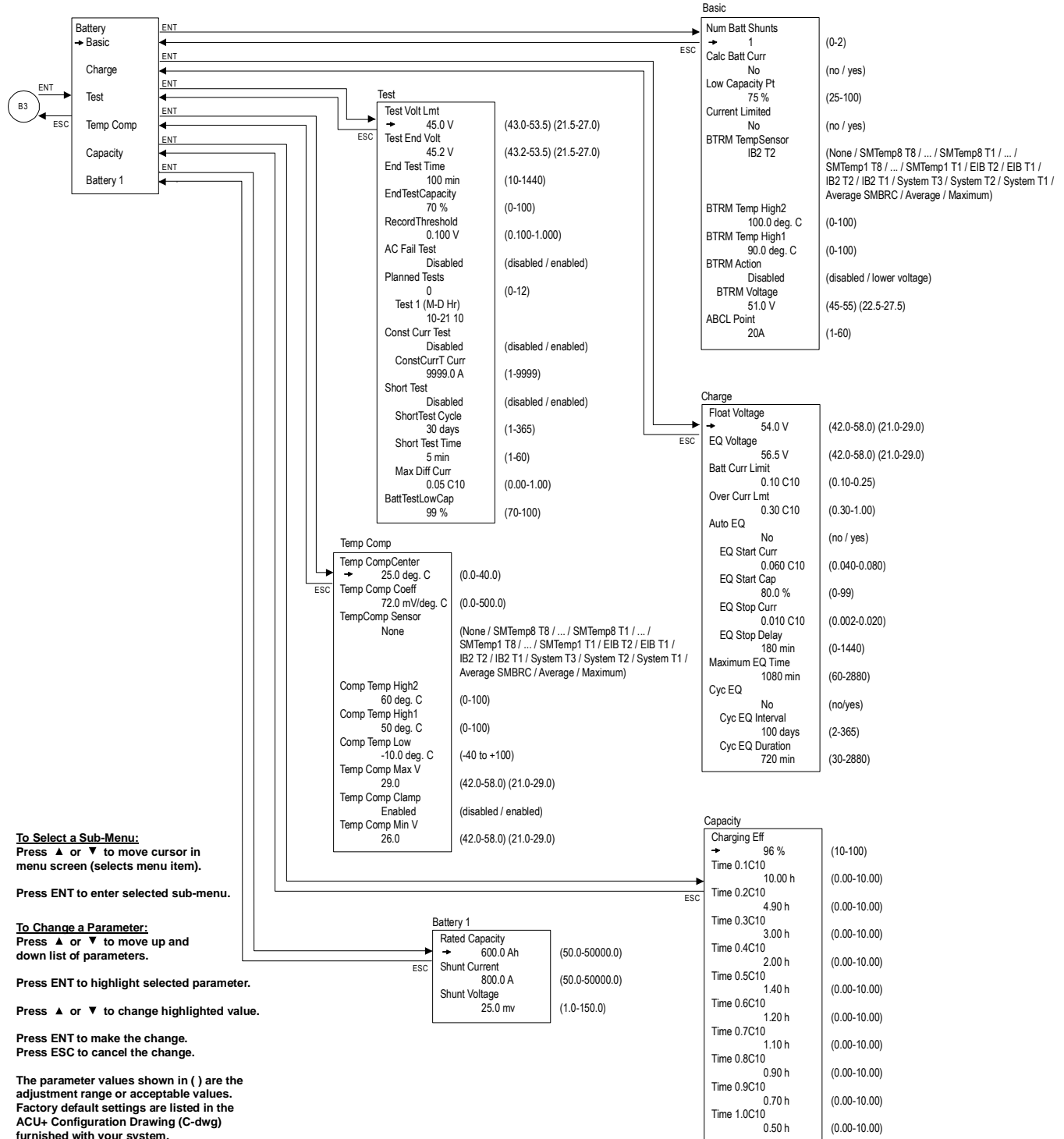

Figure 8 (cont'd from previous page, cont'd on next page)
Local Menu Flow Diagrams

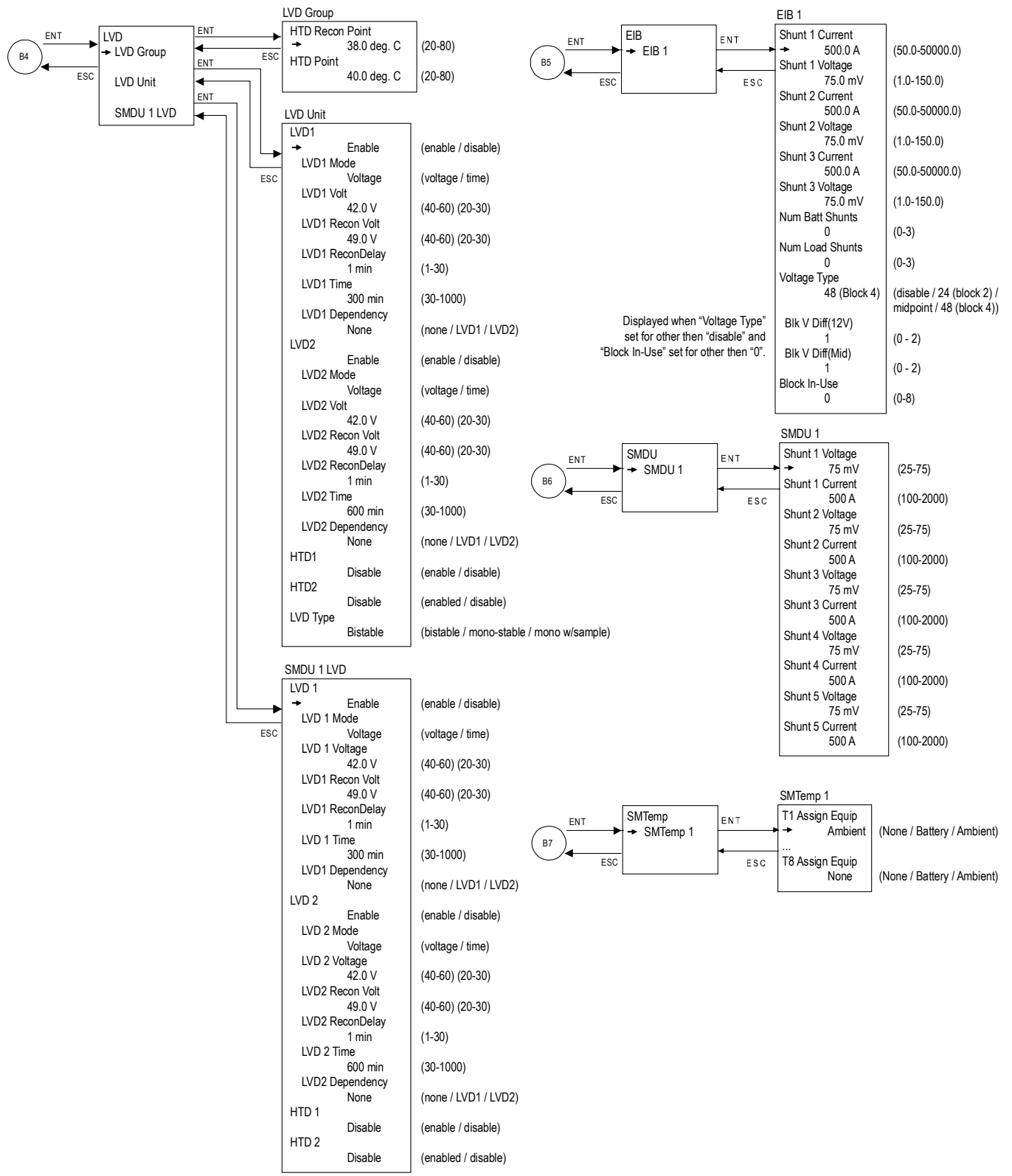

Figure 8 (cont'd from previous page, cont'd on next page)
 Local Menu Flow Diagrams

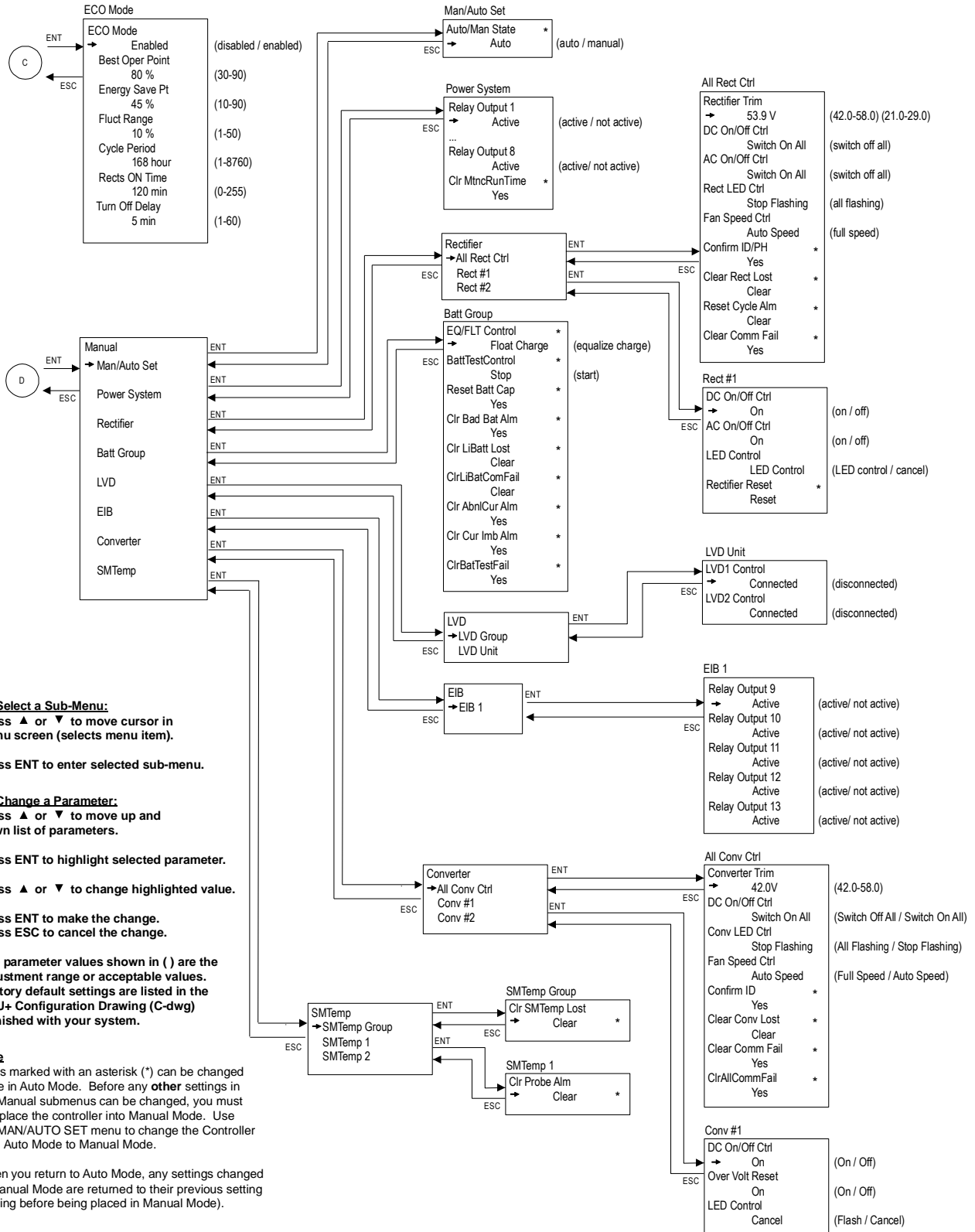

Figure 8 (cont'd from previous page, cont'd on next page)
Local Menu Flow Diagrams

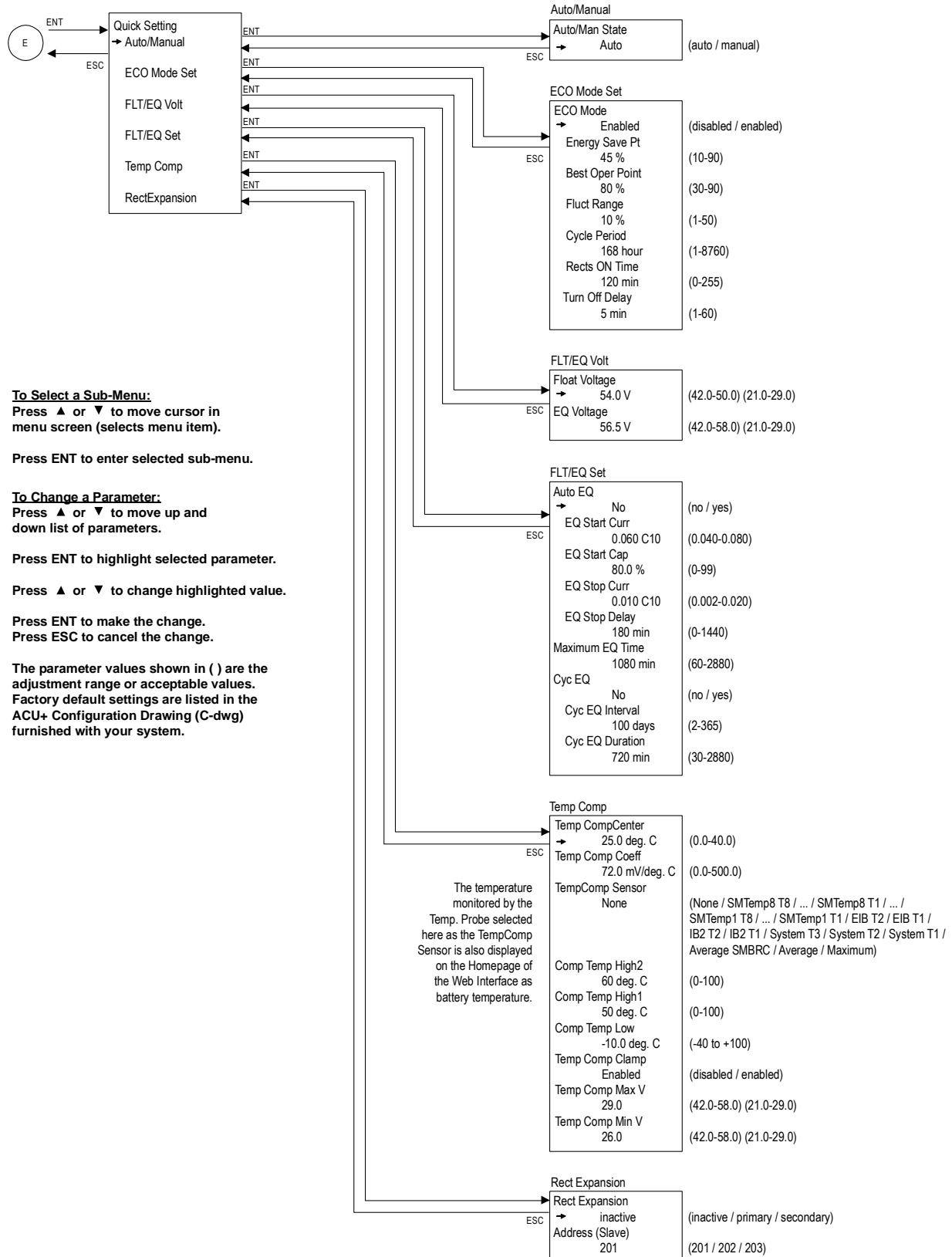

Figure 8 (cont'd from previous page)
 Local Menu Flow Diagrams

3.3 Description of Local Display (and Web Interface) Menu Line Items

The following are descriptions of the editable parameters presented in the local display menus. Parameter descriptions can also be used for the WEB Interface menus. Note that the names in the WEB Interface menu may be longer since the WEB Interface allows more characters to be displayed than the local (LCD) display.

3.3.1 Settings Menu

Alarm Setting

Alarm Severity Menu

Menu Navigation: Main Menu / Settings / Alarm Setting / Alm Severity

Note: For WEB Interface, menu item is found under Configuration / Signal Information Modification / select "Alarm Signal" in "Signal Type" drop-down box.

"Alarm Severity" Parameter Settings:

- Use the menus to assign an Alarm Severity Level (none, minor, major, critical) to each possible alarm.

Alarm Relay Menu

Menu Navigation: Main Menu / Settings / Alarm Setting / Alarm Relay

Note: For WEB Interface, menu item is found under Configuration / Alarm Relays.

"Alarm Relay" Parameter Settings:

- Use the menus to assign an alarm relay (for connection of external alarm circuits) to each possible alarm.

Alarm Param Menu

Menu Navigation: Main Menu / Settings / Alarm Setting / Alarm Param

Note: For WEB Interface; "Block Alarm" menu item is found under Device Information / Power System / Settings Tab, "Clr Alarm Hist" menu item is found under Maintenance / Clear Data, and "Alarm Voice" menu item is not available.

"Alarm Param" Parameter Settings:

- **Alarm Voice:** Programs the audible alarm feature.
 - **Off:** Disables the audible alarm.
 - **On:** When a new alarm occurs, the audible alarm sounds. Press any key to silence the audible alarm.
 - **3 minutes / 10 minutes / 1 hour / 4 hours:** When a new alarm occurs, the audible alarm sounds. The audible alarm automatically silences after the selected time period.
- **Block Alarm**
 - **Normal:** Alarms are processed normally.
 - **Blocked:** Forces the alarm relays in the "off" state and blocks alarms from changing the relay state.
- **Clr Alm Hist:** The only selection for "Clr Alm Hist" is Yes. Once Yes is selected and confirmed, the alarm history log is cleared.

Power System

General Menu

Menu Navigation: Main Menu / Settings / Power System / General

Note: For WEB Interface; menu items are found under Device Information / Power System / Settings Tab.

"General" Parameter Settings:

- **Auto/Man State**
 - **Auto:** The Controller automatically controls the power system.
 - **Manual:** A User can manually change power system control settings. When you return to Auto Mode, any settings changed in Manual Mode are returned to their previous setting (setting before being placed in Manual Mode).
- **Manual Mode Lmt:** Time delay before returning to automatic control after being set for manual control. A "0" setting disables the "Manual Mode Lmt" feature and the Controller MUST be manually set to Auto control after being set to Manual control.
- **Mtnc Cycle Time:** The maintenance cycle time is the number of days before a Maintenance Alarm is issued. To reset the maintenance timer and clear the Maintenance Alarm, clear the Maintenance Run Time (Main Menu / Manual / Power System / Clr MtncRunTime).
- **EStop / EShutdown**
 - **Disabled:** Disables the Emergency Stop and Emergency Shutdown functions.
 - **EStop:** Enables the Emergency Stop function.
 - **EShutdown:** Enables the Emergency Shutdown function.
- **Load Curr Alarm:** Sets the load current alarm point.
- **Alarm Blocked**
 - **Normal:** Alarms are processed normally.
 - **Blocked:** Forces the alarm relays in the "off" state and blocks alarms from changing the relay state.
- **Rect Expansion**
 - **Inactive:** Select this option if this is the only ACU+ Controller in the power system.
 - **Primary:** Select this option if the power system consists of multiple bays with multiple ACU+ Controllers, and this ACU+ Controller is to be the Primary Controller. Note that only one (1) ACU+ Controller can be set as the Primary Controller.
 - **Secondary:** Select this option if the power system consists of multiple bays with multiple ACU+ Controllers, and this ACU+ Controller is to be a Secondary Controller.

Up to four (4) ACU+ Controllers can be connected together when a power system requires a greater number of rectifiers than can be controlled by a single ACU+ Controller. One (1) Controller is designated as the primary Controller, the others as secondary Controllers. The rectifiers controlled by the secondary Controllers are designated as RectifierGroup 2 through 4 in the menus.

Primary/Secondary Procedure:

Note: *Changing the Rectifier Expansion setting may take more than 3 minutes for the ACU+ to configure the feature.*

- 1) Connect the ACU+ Controllers in the multiple bays via the RS485 interface.

- 2) Set one of the ACU+ Controllers as the Primary Controller via the **Rect Expansion** menu item in the **Power System "General" Parameters** menu.
- 3) Set all other ACU+ Controllers as Secondary Controllers via the **Rect Expansion** menu item in the **Power System "General" Parameters** menu.
- 4) Set the Address of the ACU+ Controllers set as Secondary Controllers to 201, 202, or 203 via the **Address (Slave)** menu item in the **Power System "General" Parameters** menu. Note that each Secondary Controller must be set to a different address.

-
- **Address (Slave):** Sets the address of an ACU+ Controller set as a Secondary Controller.
 - **Over Voltage 1:** Sets the Over Voltage 1 alarm point.
 - **Over Voltage 2:** Sets the Over Voltage 2 alarm point.
 - **Under Voltage 1:** Sets the Under Voltage 1 alarm point.
 - **Under Voltage 2:** Sets the Under Voltage 2 alarm point.
 - **Fail Safe:** When enabled, sets the relay designated as the "critical summary" alarm relay to operate in the "fail safe" mode. In this mode, the relay is energized during normal operation and de-energized for an alarm condition.
 - **Hybrid Mode:** Refer to "1.3.11 Hybrid Control Function" for more information on the Hybrid Mode.
 - **Disable / Fixed Daily / Capacity:** Sets the Hybrid Mode or disables the function.
 - **DG Run Overtemp:** Enables or disables diesel generator operation in an over temperature condition.
 - **DG Run Time:** Sets the diesel generator run time.
 - **DG Used:** Sets the diesel generator(s) to be utilized.
 - **DI for Grid:** Sets the digital input monitoring the grid.
 - **DOD:** Sets the Depth of Discharge.
 - **Dsch Duration:** Sets the discharge duration.
 - **Start Dsch Time:** Sets the start time for discharge.
 - **High Load Set:** Sets the high load point.
 - **Equal StartTime:** Sets the start time for equalizing.
 - **DG Alarm Delay:** Sets the diesel generator alarm delay.
 - **Fail Safe:** Tells the Controller the fail safe mode of the relay contacts connected to start the generator(s) (either normally open or normally close).
 - **Contactormode:** Enables or disables the Power Split feature ("master control" indicates the ACU+ system operates normally and "slave control" indicates the ACU+ system is a slave system of the existing legacy system).

See also "2.7 Power Split Feature".
 - **Relay Test:** Sets the Relay Test feature to Automatic, Individual, or disables the feature.
 - **Relay Test Time:** Sets the Relay Test Time for the Automatic Relay Test feature.
 - **HighLoadLevel1:** Sets the High Load Level 1 alarm.
 - **HighLoadLevel2:** Sets the High Load Level 2 alarm.
 - **DI1 through DI18 Alarm State:** Sets the alarm state for the digital input (high or low).
 - **Amb Temp Sensor:** Sets the temperature sensor which displays the ambient temperature on the Web Interface's Homepage. Note that this temperature sensor **MUST** be set as an

ambient temperature sensor. Select "None", or the temperature probe (SMTemp8 T8 / ... / SMTemp8 T1 / ... / SMTemp1 T8 / ... / SMTemp1 T1 / EIB T2 / EIB T1 / IB2 T2 / IB2 T1). You can also select Maximum or Average which takes the maximum or average reading of the temperature probes (any of SMTemp8 T8 / ... / SMTemp8 T1 / ... / SMTemp1 T8 / ... / SMTemp1 T1 / EIB T2 / EIB T1 / IB2 T2 / IB2 T1) set as ambient temperature probes.

- **Amb Temp High2:** Allows you to set a high ambient temperature alarm 2 point.
- **Amb Temp High1:** Allows you to set a high ambient temperature alarm 1 point.
- **Amb Temp Low:** Allows you to set a low ambient temperature alarm point.
- **System Temp1:** Not used.
- **System Temp2:** Not used.
- **System Temp3:** Not used.
- **IB2 Temp1:** Sets temperature port 1 on the IB2 board to None, Battery, or Ambient.
- **IB2 Temp2:** Sets temperature port 2 on the IB2 board to None, Battery, or Ambient.
- **EIB Temp1:** Sets temperature port 1 on the EIB board to None, Battery, or Ambient.
- **EIB Temp2:** Sets temperature port 2 on the EIB board to None, Battery, or Ambient.

Note: You can set High2, High1, and Low temperature alarms for each temperature sensor (from the Web Interface). Note that you cannot set high and low temperature alarms for individual temperature sensors from the Local Menus. High and low temperature alarm settings for the temperature sensors set as ambient are found in the Device Information / Power System / Settings tab. High and low temperature alarm settings for the probes set as battery are found in the Device Information / Battery Group / Settings tab.

Power Split Menu

See also "2.7 Power Split Feature".

Menu Navigation: Main Menu / Settings / Power System / Power Split

Note: For WEB Interface; menu items are found under Device Information / Power System / Settings Tab.

"Power Split" Parameter Settings:

- **Slave Curr Lmt:** Current limit point for power system designated as the slave system in a "Power Split" configuration.
- **Delta Volt:** The offset voltage that the power system designated as the slave system in a "Power Split" configuration is set to. It is suggested to leave this value at the default (0.5 volts).
- **Proportion Coeff:** The proportional coefficient that the power system designated as the slave system in a "Power Split" configuration is set to. It is suggested to leave this value at the default (30%).
- **Integral Time:** The integral time that the power system designated as the slave system in a "Power Split" configuration is set to. It is suggested to leave this value at the default (60 seconds).

Rectifier

All Rect Set Menu

Menu Navigation: Main Menu / Settings / Rectifier / All Rect Set

Note: For WEB Interface; menu items are found under Device Information / Rectifier Group / Settings Tab.

"All Rect Set" Parameter Settings:

- **HVSD:** Enables or disables the High Voltage Shutdown feature for all rectifiers.
 - **HVSD Limit:** Sets the High Voltage Shutdown point for all rectifiers.
- **Restart on HVSD:** Enables or disables the High Voltage Shutdown Restart feature for all rectifiers.
- **HVSD Restart T:** When the High Voltage Shutdown Restart feature is enabled and the output exceeds the high voltage limit, the rectifiers restart after this time period expires.
- **Start Interval:** Sets the sequence start interval (time period between starting each rectifier in the system).
- **Walk-In:** Enables or disables the start-up walk-in feature for all rectifiers.
- **Walk-In Time:** Sets the walk-in time period for all rectifiers.
- **Turn On ACOverV:** Enables or disables the "Turn On AC Over Voltage" feature. When the system is operating on "week" grid input power (i.e. diesel generator), the input voltage may have a very high peak voltage which may cause a rectifier not to turn on. If "Turn On AC Over Voltage" feature is enabled, the rectifier is forced to turn on.
- **ECO Mode:** Enables or disables the Energy Optimization feature for all rectifiers. When enabled, the following parameters can be set.
 - **Best Oper Point:** Percent of full load capacity that the rectifiers operate under in the Energy Optimization mode.
 - **Fluct Range:** If load fluctuation is less than this value, rectifiers are not turned on or off for Energy Optimization.
 - **Energy Save Pt:** Energy Optimization is disabled if the load is greater than this setting.
 - **Cycle Period:** This is the time period that rectifiers are turned on and off to maintain an equal operating time for all rectifiers in the system.
 - **Rects ON Time:** Time all rectifiers are turned on at End of Cycle.
 - **Turn Off Delay:** When the Energy Optimization feature determines a rectifier can be switched off, this is the time delay before the rectifier is switched off.
- **Input Curr Lmt:** Sets the Input Current Limit point for all rectifiers.
- **MixHE Power:** Allows the system to use rectifiers of different output capacity. When set to derated power, the output capacity of the higher capacity rectifiers are set to the capacity of the lowest.
- **DG Pwr Lmt:** Enables or disables the Diesel Power Limit feature. This feature limits rectifier output power to a percentage of maximum when AC input is supplied by a diesel-alternator set.
 - **Diesel DI Input:** Designates which digital input controls operation of the Diesel Power Limit feature.
 - **DG Pwr Lmt Pt:** Sets, as a percentage, the maximum output power at which rectifiers can operate when: 1. the Diesel Power Limit feature is enabled and 2. a digital input signal is received from the connected diesel-alternator set.
- **Current Limit:** Enables or disables output current limit.
- **Current Limit Pt:** Sets the output current limit point.

Rect #1 Menu

Menu Navigation: Main Menu / Settings / Rectifier / Rect #1

Note: For WEB Interface; menu items are found under Device Information / Rectifier Group / Rectifier #1 / Settings Tab.

" Rect #1 " Parameter Settings:

- **Rectifier ID:** Sets the rectifier position in the system.
- **Rect Phase:** Indicates the phase connected to the rectifier input.

Battery

Basic Menu

Menu Navigation: Main Menu / Settings / Battery / Basic

Note: For WEB Interface; menu items are found under Device Information / Battery Group / Settings Tab.

"Basic" Parameter Settings:

- **Num Batt Shunts:** Sets the number of battery shunts in the system.
- **Calc Batt Curr:** Selects whether or not the ACU+ calculates the battery current in the case of no battery shunt (load shunt required).
- **Low Capacity Pt:** Battery low capacity alarm set point.
- **Current Limited:** Enables or disables battery charge current limit.
- **BTRM TempSensor:** Sets the BTRM (Battery Thermal Runaway Management) temperature sensor. Note that this temperature sensor **MUST** be set as a battery temperature sensor. Select "None", or the temperature probe (SMTemp8 T8 / ... / SMTemp8 T1 / ... / SMTemp1 T8 / ... / SMTemp1 T1 / EIB T2 / EIB T1 / IB2 T2 / IB2 T1). You can also select Maximum or Average which takes the maximum or average reading of the temperature probes (any of SMTemp8 T8 / ... / SMTemp8 T1 / ... / SMTemp1 T8 / ... / SMTemp1 T1 / EIB T2 / EIB T1 / IB2 T2 / IB2 T1) set as battery temperature probes. When used with an SM-BRC, you can select to average the SM-BRC temperature probe readings.

Note: *The BTRM sensor is the sensor which is used for the High Temperature Disconnect (HTD) Feature.*

- **BTRM Temp High2:** Allows you to set a high BTRM temperature alarm 2 point. If battery temperature exceeds the "BTRM Temp High2" setting, system voltage is lowered to the "BTRM Voltage" setting (if BTRM Action is enabled).
- **BTRM Temp High1:** Allows you to set a high BTRM temperature alarm 1 point.
- **BTRM Action**
 - **Disabled:** Disables the Battery Thermal Runaway Management feature.
 - **Lower Voltage:** Sets the Battery Thermal Runaway Management feature to reducing the output voltage when battery temperature exceeds the BTRM Temp setting.
 - **BTRM Voltage:** Voltage that the system is set to when battery temperature exceeds the "BTRM Temp High2" setting.
- **ABCL Point:** The ABCL (Active Battery Charge Current Limit) point is the maximum Li-Ion battery charging current setting.

Charge Menu

Menu Navigation: Main Menu / Settings / Battery / Charge

Note: For WEB Interface; menu items are found under Device Information / Battery Group / Settings Tab.

"Charge" Parameter Settings:

- **Float Voltage:** Float Charge output voltage setting.
- **EQ Voltage:** Equalize Charge output voltage setting.

- **Batt Curr Limit:** Maximum battery charging current setting. For example, a value of 0.150C10 means that the charging current is limited to 15% of the battery's nominal capacity.
- **Over Curr Lmt:** Battery over current alarm setting. For example, a value of 0.300C10 means that when the charging current reaches 30% of the battery's nominal capacity, an alarm will be extended.
- **Auto EQ:** Enables or disables the Automatic Equalize Charge feature. When enabled, the following parameters can be set.
 - **EQ Start Curr:** The system is transferred to Equalize Charge mode when battery charge current increases to this setting. For example, a value of 0.060C10 means that an Automatic Equalize is started if the battery charge current is greater than 6% of the battery's nominal capacity.
 - **EQ Start Cap:** The system is transferred to Equalize Charge mode when remaining battery capacity decreases to this setting.
 - **EQ Stop Curr:** When in Equalize Charge mode and the battery charge current decreases below this setting for the "EQ Stop Delay" time period, the system is transferred to Float Charge mode. For example, a value of 0.010C10 means that when the charging current is less than 1% of the battery's nominal capacity, the system returns to the Float mode.
 - **EQ Stop Delay:** See "EQ Stop Curr" above.

Note: *If the power system has been automatically placed in Equalize mode, disabling Auto EQ will **not** return the system to Float mode until the current Equalize cycle is completed. To return immediately to Float mode, navigate as follows: Main Menu / Manual / Batt Group / "EQ/FLT Control", and select Float Charge.*

- **Maximum EQ Time:** This is the maximum duration, in minutes, that an Automatic Equalize Charge will last regardless of the other settings.
- **Cyc EQ:** Enables or disables cyclic (scheduled) Equalize charging. When enabled, the following parameters can be set.
 - **Cyc EQ Interval:** Cyclic (scheduled) Equalize charging interval.
 - **Cyc EQ Duration:** Cyclic (scheduled) Equalize charging duration.

Test Menu

Menu Navigation: Main Menu / Settings / Battery / Test

Note: For WEB Interface; menu items are found under Device Information / Battery Group / Settings Tab.

"Test" Parameter Settings:

- **Test Volt Lmt:** System output voltage setting during a battery discharge test.
- **Test End Volt:** This is the "end of test voltage level" for battery discharge tests. A battery discharge test will end if battery voltage decreases to this setting.
- **End Test Time:** This is the "end of test time period" for battery discharge tests. A battery discharge test will end if this time period is exceeded.
- **EndTestCapacity:** This is the "end of test remaining battery capacity" for battery discharge tests. A battery discharge test will end if remaining battery capacity decreases to this setting. For example, a value of 0.700C10 means that when the discharging current reaches 70% of the battery's nominal capacity, the battery test is ended.
- **RecordThreshold:** This setting indicates the interval battery voltage is recorded during a battery discharge test.

- **AC Fail Test:** Enables or disables starting a battery discharge test during an AC input failure condition.
- **Planned Tests:** Number of planned battery discharge test per year. A "0" setting disables the planned test feature.
 - **Test 1 (M-D Hr):** Setting for when planned battery discharge test #1 occurs. Note that there can be up to (12) battery discharge tests per year.
- **Const Curr Test:** Enables or disables a Constant Current Battery Discharge Test. During this test, the Controller automatically adjusts the rectifiers output voltage to maintain the battery discharge current at a preset value "ConstCurrT Curr".
 - **ConstCurrT Curr:** Constant current setting for a Constant Current Battery Discharge Test.
- **Short Test:** Enables or disables a Short Battery Discharge Test. A Short Battery Discharge Test is a short duration battery discharge test used to verify that parallel batteries are discharging equally. If the discharge current difference between the two batteries exceeds a preset value, an alarm is generated.

Note: This test requires a system with two battery shunts.

 - **ShortTest Cycle:** Short Battery Discharge Test interval.
 - **Short Test Time:** Short Battery Discharge Test duration.
 - **Max Diff Curr:** An alarm is generated if the maximum difference between discharge currents of the two batteries exceeds this limit.
- **BattTestLowCap:** If remaining battery capacity is less than this value, a battery discharge test will not be started.

Temp Comp Menu

Menu Navigation: Main Menu / Settings / Battery / Temp Comp

Note: For WEB Interface; menu items are found under Device Information / Battery Group / Settings Tab.

"Temp Comp" Parameter Settings:

- **Temp CompCenter:** Sets the temperature at which the system operates at normal voltage levels.
- **Temp Comp Coeff:** Sets the temperature compensation slope or rate of change per °C above or below the "Temp Comp" setting. This value is expressed in millivolt per °C per string (mV/°C/str). For example, for a rate of change of **72 mV/°C/str** in a 24-cell 48V nominal battery string, the rate of change is 3 mV per cell.
- **TempComp Sensor:** Select "None" for no temperature compensation, or the temperature probe (SMTemp8 T8 / ... / SMTemp8 T1 / ... / SMTemp1 T8 / ... / SMTemp1 T1 / EIB T2 / EIB T1 / IB2 T2 / IB2 T1) sensing battery temperature for temperature compensation. You can also select Maximum or Average which takes the maximum or average reading of the temperature probes (any of SMTemp8 T8 / ... / SMTemp8 T1 / ... / SMTemp1 T8 / ... / SMTemp1 T1 / EIB T2 / EIB T1 / IB2 T2 / IB2 T1) set as battery temperature probes. When used with an SM-BRC, you can select to average the SM-BRC temperature probe readings.

Note: The temperature compensation sensor is also the sensor which displays the battery temperature on the Web Interface's Homepage.
- **Comp Temp High2:** Allows you to set a high compensation temperature alarm 2 point.
- **Comp Temp High1:** Allows you to set a high compensation temperature alarm 1 point.
- **Comp Temp Low:** Allows you to set a low compensation temperature alarm point.

- **Temp Comp Clamp:** Enables or disables the temperature compensation voltage clamp feature.
- **Temp Comp Max V:** Upper voltage limit where battery temperature compensation clamps the voltage.
- **Temp Comp Min V:** Lower voltage limit where battery temperature compensation clamps the voltage.

Capacity Menu

Menu Navigation: Main Menu / Settings / Battery / Capacity

Note: For WEB Interface; menu items are found under Device Information / Battery Group / Settings Tab.

"Capacity" Parameter Settings:

- **Charging Eff:** Value used to calculate remaining capacity of the battery.
- **Time 0.1C10:** Discharge time with a discharge current of 0.1C10.
- **Time 0.2C10:** Discharge time with a discharge current of 0.2C10.
- **Time 0.3C10:** Discharge time with a discharge current of 0.3C10.
- **Time 0.4C10:** Discharge time with a discharge current of 0.4C10.
- **Time 0.5C10:** Discharge time with a discharge current of 0.5C10.
- **Time 0.6C10:** Discharge time with a discharge current of 0.6C10.
- **Time 0.7C10:** Discharge time with a discharge current of 0.7C10.
- **Time 0.8C10:** Discharge time with a discharge current of 0.8C10.
- **Time 0.9C10:** Discharge time with a discharge current of 0.9C10.
- **Time 1.0C10:** Discharge time with a discharge current of 1.0C10.

Battery # Menu

Menu Navigation: Main Menu / Settings / Battery / Battery #

Note: For WEB Interface; menu items are found under Device Information / Battery Group / Battery # / Settings Tab.

"Battery #" Parameter Settings:

- **Rated Capacity:** Enter the battery string's rated capacity.
- **Shunt Current:** Enter the battery string's shunt current rating.
- **Shunt Voltage:** Enter the battery string's shunt voltage rating.

BattFuseUnit

BattFuseUnit Menu

Menu Navigation: Main Menu / Settings / BattFuseUnit

Note: For WEB Interface; menu items are found under Device Information / Battery Fuse Group / Battery Fuse Unit / Settings Tab.

"BattFuseUnit" Parameter Settings:

- **Num of Bat Fuse:** Designates the number of battery fuses in the system.

DC

DC Menu

Menu Navigation: Main Menu / Settings / DC

Note: For WEB Interface; menu items are found under Device Information / DC / Settings Tab.

"DC" Parameter Settings:

- **Shunt Current:** Enter the load shunt's current rating.
- **Shunt Voltage:** Enter the load shunt's voltage rating.
- **LoadShuntExist:** Select whether a load shunt exists or not.

LVD

LVD Group Menu

Menu Navigation: Main Menu / Settings / LVD / LVD Group

Note: For WEB Interface; menu items are found under Device Information / LVD Group / Settings Tab.

Note: *This feature requires a BTRM sensor. The BTRM sensor is the sensor which is used for the High Temperature Disconnect (HTD) Feature.*

"LVD Group" Parameter Settings:

- **HTD Recon Point:** Sets temperature at which a reconnect will occur following a High Temperature Disconnect.
- **HTD Point:** Sets high temperature limit at which LVD1 and/or LVD2 contactors will open (disconnect) if the HTD1 and/or HTD2 features are enabled. If this temperature is reached, a disconnect occurs regardless of voltage.

LVD Unit Menu

Menu Navigation: Main Menu / Settings / LVD / LVD Unit

Note: For WEB Interface; menu items are found under Device Information / LVD Group / LVD Unit / Settings Tab.

"LVD Unit" Parameter Settings:

- **LVD1:** Enables or disables LVD1.
 - **LVD1 Mode:** Sets LVD1 to disconnect on a voltage or time setpoint.
 - **LVD1 Volt:** LVD1 low voltage disconnect setting (when LVD set for voltage).
 - **LVD1 Recon Volt:** LVD1 reconnect setting (when LVD set for voltage).
 - **LVD1 ReconDelay:** Delay time period until LVD1 reconnects once voltage recovers (when LVD set for voltage).
 - **LVD1 Time:** The time period before LVD1 disconnection once an AC fail condition occurs (when LVD set for time).
 - **LVD1 Dependency:** Select if LVD1 can disconnect only if LVD2 has disconnected, or none.
- **LVD2:** Enables or disables LVD2.
 - **LVD2 Mode:** Sets LVD2 to disconnect on a voltage or time setpoint.
 - **LVD2 Volt:** LVD2 low voltage disconnect setting (when LVD set for voltage).
 - **LVD2 Recon Volt:** LVD2 reconnect setting (when LVD set for voltage).
 - **LVD2 ReconDelay:** Delay time period until LVD2 reconnects once voltage recovers (when LVD set for voltage).
 - **LVD2 Time:** The time period before LVD2 disconnection once an AC fail condition occurs (when LVD set for time).
 - **LVD2 Dependency:** Select if LVD2 can disconnect only if LVD1 has disconnected, or none.

- **HTD1:** Enables or disables the High Temperature 1 Disconnect feature. This feature causes LVD1 contactors to open (disconnect) if a high temperature event occurs. (See HTD selections in the "*LVD Group*" *Parameter Settings*.)
- **HTD2:** Enables or disables the High Temperature 2 Disconnect feature. This feature causes LVD2 contactors to open (disconnect) if a high temperature event occurs. (See HTD selections in the "*LVD Group*" *Parameter Settings*.)
- **LVD Type:** Select the type of LVD Contactor. This setting should not be changed.

SMDU 1 LVD Menu

Menu Navigation: Main Menu / Settings / LVD / SMDU 1 LVD

Note: For WEB Interface; menu items are found under Device Information / LVD Group / SMDU 1 LVD / Settings Tab.

"SMDU 1 LVD" Parameter Settings:

- **LVD 1:** Enables or disables LVD1.
 - **LVD 1 Mode:** Sets LVD1 to disconnect on a voltage or time setpoint.
 - **LVD 1 Voltage:** LVD1 low voltage disconnect setting (when LVD set for voltage).
 - **LVD1 Recon Volt:** LVD1 reconnect setting (when LVD set for voltage).
 - **LVD1 ReconDelay:** Delay time period until LVD1 reconnects once voltage recovers (when LVD set for voltage).
 - **LVD 1 Time:** The time period before LVD1 disconnection once an AC fail condition occurs (when LVD set for time).
 - **LVD1 Dependency:** Select if LVD1 can disconnect only if LVD2 has disconnected, or none.
- **LVD 2:** Enables or disables LVD2.
 - **LVD 2 Mode:** Sets LVD2 to disconnect on a voltage or time setpoint.
 - **LVD 2 Voltage:** LVD2 low voltage disconnect setting (when LVD set for voltage).
 - **LVD2 Recon Volt:** LVD2 reconnect setting (when LVD set for voltage).
 - **LVD2 ReconDelay:** Delay time period until LVD2 reconnects once voltage recovers (when LVD set for voltage).
 - **LVD 2 Time:** The time period before LVD2 disconnection once an AC fail condition occurs (when LVD set for time).
 - **LVD2 Dependency:** Select if LVD2 can disconnect only if LVD1 has disconnected, or none.
- **HTD 1:** Enables or disables the High Temperature 1 Disconnect feature. This feature causes LVD1 contactors to open (disconnect) if a high temperature event occurs. (See HTD selections in the "*LVD Group*" *Parameter Settings*.)
- **HTD 2:** Enables or disables the High Temperature 2 Disconnect feature. This feature causes LVD2 contactors to open (disconnect) if a high temperature event occurs. (See HTD selections in the "*LVD Group*" *Parameter Settings*.)

AC

Rect AC Menu

Menu Navigation: Main Menu / Settings / AC / Rect AC

Note: For WEB Interface; menu items are found under Device Information / AC Group / Rect AC / Settings Tab.

"Rect AC" Parameter Settings:

- **Nominal PH-Volt:** Enter the nominal line-to-neutral voltage (single phase rectifier) or nominal line-to-line voltage (three phase rectifier).
- **Mains Fail Alm1:** Sets the Mains Fail Alarm 1 value (percent of nominal).
- **Mains Fail Alm2:** Sets the Mains Fail Alarm 2 value (percent of nominal).

Corresponding Alarms:

- Phase A Voltage Low 1 (Nominal Minus "Mains Fail Alarm 1 Percent of Nominal)
- Phase A Voltage Low 2 (Nominal Minus " Mains Fail Alarm 2 Percent of Nominal)
- Phase A Voltage High 1 (Nominal Plus " Mains Fail Alarm 1 Percent of Nominal)
- Phase A Voltage High 2 (Nominal Plus "V Mains Fail Alarm 2 Percent of Nominal)

Phase A used in the example above, Phase B and Phase C are similar.

EIB

EIB 1 Menu

Menu Navigation: Main Menu / Settings / EIB / EIB 1

Note: For WEB Interface; menu items are found under Device Information / EIB Group / EIB 1 / Settings Tab.

"EIB 1" Parameter Settings:

- **Shunt 1 Current:** Enter the shunt 1 current rating.
- **Shunt 1 Voltage:** Enter the shunt 1 voltage rating.
- **Shunt 2 Current:** Enter the shunt 2 current rating.
- **Shunt 2 Voltage:** Enter the shunt 2 voltage rating.
- **Shunt 3 Current:** Enter the shunt 3 current rating.
- **Shunt 3 Voltage:** Enter the shunt 3 voltage rating.
- **Num Batt Shunts:** Enter the number of battery shunts connected to the EIB assembly.
- **Num Load Shunts:** Enter the number of load shunts connected to the EIB assembly.
- **Voltage Type:** The EIB assembly provides a total of eight (8) DC voltage inputs for battery block monitoring. 24 (Block 2) selects the EIB to monitor up to four (4) 24V battery strings with two (2) 12V blocks per string. 48 (Block 4) selects the EIB to monitor up to two (2) 48V battery strings with four (4) 12V blocks per string. Midpoint selects the EIB to monitor the midpoint voltage of up to eight (8) battery strings for either 24V or 48V systems.
 - **Blk V Diff(12V):** This menu item appears if "24 (Block 2)" or "48 (Block 4)" is selected above. The "BlockVDiff(12V)" setting above selects the alarm threshold for battery block monitoring. The ACU+ issues an alarm when any block voltage of any battery string has an abnormal value. The alarm is issued when the difference between any block voltage and a reference voltage is greater than the value of the block voltage difference setting.
 - **Blk V Diff(Mid):** This menu item appears if "Midpoint" is selected above. The "BlockVDiff(Mid)" setting above selects the alarm threshold for battery midpoint monitoring. The ACU+ issues an alarm when any battery midpoint voltage of any battery string has an abnormal value. The alarm is issued when the difference between any battery midpoint voltage and a reference voltage is greater than the value of the block voltage difference setting.
- **Block In-Use:** Number of 12V battery blocks being used.

SMDU

SMDU 1 Menu

Menu Navigation: Main Menu / Settings / SMDU / SMDU 1

Note: For WEB Interface; menu items are found under Device Information / SMDU Group / SMDU 1 / Settings Tab.

"SMDU 1" Parameter Settings:

- **Shunt 1 Voltage:** Enter the shunt 1 voltage rating.
- **Shunt 1 Current:** Enter the shunt 1 current rating.
- **Shunt 2 Voltage:** Enter the shunt 2 voltage rating.
- **Shunt 2 Current:** Enter the shunt 2 current rating.
- **Shunt 3 Voltage:** Enter the shunt 3 voltage rating.
- **Shunt 3 Current:** Enter the shunt 3 current rating.
- **Shunt 4 Voltage:** Enter the shunt 4 voltage rating.
- **Shunt 4 Current:** Enter the shunt 4 current rating.
- **Shunt 5 Voltage:** Enter the shunt 5 voltage rating.
- **Shunt 5 Current:** Enter the shunt 5 current rating.

Converter

All Conv Set Menu

Menu Navigation: Main Menu / Settings / Converter / All Conv Set

Note: For WEB Interface; menu items are found under Device Information / Converter Group / Settings Tab.

"All Conv Set" Parameter Settings:

- **Output Voltage:** Sets the output voltage for all converters.
- **Under Voltage:** Sets the Under Voltage alarm point.
- **Over Voltage:** Sets the Over Voltage alarm point.
- **Over Current:** Sets the Over Current alarm point.
- **HVSD:** Enables or disables the High Voltage Shutdown feature for all converters.
 - **HVSD Limit:** Sets the High Voltage Shutdown point for all converters.
- **Current Limit:** Enables or disables output current limit.
- **Current Limit Pt:** Sets the output current limit point.

Conv #1 Menu

Menu Navigation: Main Menu / Settings / Converter / Conv #1

Note: For WEB Interface; menu items are found under Device Information / Converter Group / Converter #1 / Settings Tab.

"Conv #1" Parameter Settings:

- **Set Conv ID:** Sets the converter position in the system.

SMPtemp

SMPtemp # Menu

Menu Navigation: Main Menu / Settings / SMPtemp / SMPtemp #

Note: For WEB Interface; menu items are found under Device Information / SM Temp Group / SM Temp # / Setting Tab.

"SMPtemp #" Parameter Settings:

- **T# Assign Equip:** Sets temperature port # on the SM-Temp # module to None, Battery, or Ambient.

Note: You can set High2, High1, and Low temperature alarms for each temperature sensor (from the Web Interface). Note that you cannot set high and low temperature alarms for individual temperature sensors from the Local Menus. High and low temperature alarm settings for the temperature sensors set as ambient are found in the Device Information / Power System / Settings tab. High and low temperature alarm settings for the probes set as battery are found in the Device Information / Battery Group / Settings tab.

Communication

Communication Menu

Menu Navigation: Main Menu / Settings / Communication

Note: For WEB Interface; menu items are found under Maintenance / Network Configuration.

"Communication" Parameter Settings:

- **DHCP:** The DHCP function allows the Controller to acquire an IP address automatically. This function can only be enabled or disabled via the local LCD display and keypad. If this function is enabled and the acquisition of an IP address fails, an alarm is generated. If the acquisition of an IP address is successful, you need to record the IP address automatically acquired by the Controller to access the Controller via the Web Interface.
- **IP Address:** Sets the Controller's IP address.
Enter the address in the format nnn.nnn.nnn.nnn, where $0 \leq nnn \leq 255$.
The address must be a valid address and must not be 255.255.255.255.
- **Subnet Mask:** Sets the Controller's network netmask.
Enter the address in the format nnn.nnn.nnn.nnn, where $0 \leq nnn \leq 255$.
- **Default Gateway:** Sets the Controller's gateway address.
Enter the address in the format nnn.nnn.nnn.nnn, where $0 \leq nnn \leq 255$.
This is the address of the gateway of the network on which the Controller resides.
The address must be a valid address and must not be 255.255.255.255.

Controller

Controller Menu

Menu Navigation: Main Menu / Settings / Controller

Note: For WEB Interface; menu items are found under the Maintenance and Configuration menus.

"Controller" Parameter Settings:

- **Language:** Select the language the menus are displayed in.
- **Date:** Sets the date.
- **Time:** Sets the time.
- **Keypad Voice:** Sets the keypad sound on or off.
- **Reload Config:** Reloads the configuration that resides in memory (restores factory defaults).

- **Download Config:** Downloads a configuration file into the Controller.
- **Auto Config:** Auto configures the Controller for the devices connected to it.

3.3.2 ECO Mode (Energy Optimization) Menu

Menu Navigation: Main Menu / ECO Mode

Note: For WEB Interface; menu items are found under Quick Settings / ECO Mode Setting.

"ECO Mode" Parameter Settings:

- **ECO Mode:** Enables or disables the Energy Optimization Mode feature for all rectifiers. When enabled, the following parameters can be set.
 - **Best Oper Point:** Percent of full load capacity that the rectifiers operate under in the Energy Optimization mode.
 - **Energy Save Pt:** Energy Optimization is disabled if the load is greater than this setting.
 - **Fluct Range:** If load fluctuation is less than this value, rectifiers are not turned on or off for Energy Optimization.
 - **Cycle Period:** This is the time period that rectifiers are turned on and off to maintain an equal operating time for all rectifiers in the system.
 - **Rects ON Time:** Time all rectifiers are turned on at End of Cycle.
 - **Turn Off Delay:** When the Energy Optimization feature determines a rectifier can be switched off, this is the time delay before the rectifier is switched off.

3.3.3 Manual Menu

Note: Menu items shown with an asterisk (*) can be changed while in Auto Mode. Before any **other** settings in this section can be changed, you must first place the ACU+ in the Manual mode. See "Man/Auto Set Parameter Settings" for a procedure.

Items that can only be changed in the Manual mode will revert to their previous settings when the Controller is returned to the Auto mode.

Man/Auto Set

Man/Auto Set Menu

Menu Navigation: Main Menu / Manual / "Man/Auto Set"

Note: For WEB Interface; menu items are found under Quick Settings / "Auto/Manual Setting".

"Man/Auto Set" Parameter Settings:

- **Auto/Man State***
 - **Auto:** The Controller automatically controls the power system.
 - **Manual:** A User can manually change certain power system control settings via the following menus. (See Note above.) This provides a convenient means of making temporary adjustment changes for testing purposes.

Power System

Power System Menu

Menu Navigation: Main Menu / Manual / Power System

Note: For WEB Interface; menu items are found under Device Information / Power System / select the Control tab.

"Power System" Parameter Settings:

- **Relay Output 1 through 8:** Temporarily sets the relay to active or not active. Setting reverts to original when Controller is returned to the Auto mode.

- **Clr MtncRunTime***: The only selection for "Clear Maintenance Run Time" is Yes. Once Yes is selected and confirmed, the Power System's Maintenance Run Time log is cleared.

Rectifier

All Rect Ctrl Menu

Menu Navigation: Main Menu / Manual / Rectifier / All Rect Ctrl

Note: For WEB Interface; menu items are found under Device Information / Rectifier Group / select the Control tab.

"All Rect Ctrl" Parameter Settings:

- **Rectifier Trim:** Temporarily sets the output voltage for all rectifiers. Voltage can be increased or decreased from the existing Float Charge or Equalize Charge setting, depending which mode the Controller was in when set to "Manual". Setting reverts to original when Controller is returned to the Auto mode.
- **DC On/Off Ctrl:** Temporarily turns the DC output on or off for all rectifiers. Setting returns to original when Controller is returned to the Auto mode.
- **AC On/Off Ctrl:** Temporarily turns the AC input on or off for all rectifiers. Setting returns to original when Controller is returned to the Auto mode.
- **Rect LED Ctrl:** Temporarily sets whether or not a rectifier's local power indicator blinks when the Controller is communicating with the rectifier. Setting returns to original when Controller is returned to the Auto mode.
- **Fan Speed Ctrl:** Temporarily sets the fan speed for all rectifiers. Setting returns to original when Controller is returned to the Auto mode.
- **Confirm ID/PH*:** Confirms the position and input phase for all rectifiers.
- **Clear Rect Lost*:** Clears a rectifier lost alarm.
- **Reset Cycle Alm*:** Clears a rectifier oscillator alarm.
- **Clear Comm Fail*:** Clears a rectifier communication fail alarm.

Rect #1 Menu

Menu Navigation: Main Menu / Manual / Rectifier / Rect #1

Note: For WEB Interface; menu items are found under Device Information / Rectifier Group / Rectifier #1 / select the Control tab.

"Rect #1" Parameter Settings:

- **DC On/Off Ctrl:** Temporarily turns the rectifier's DC output on or off. Setting returns to original when Controller is returned to the Auto mode.
- **AC On/Off Ctrl:** Temporarily turns the rectifier's AC input on or off. Setting returns to original when Controller is returned to the Auto mode.
- **LED Control:** Temporarily sets whether or not the rectifier's local power indicator blinks when the Controller is communicating with the rectifier. Setting returns to original when Controller is returned to the Auto mode.
- **Rectifier Reset*:** Resets the rectifier.

Batt Group

Batt Group Menu

Menu Navigation: Main Menu / Manual / Batt Group

Note: For WEB Interface; menu items are found under Device Information / Battery Group / select the Control tab.

"Batt Group" Parameter Settings:

- **EQ/FLT Control***: Places the system in Equalize Charge or Float Charge mode.
- **BattTestControl***: Starts or stops a Battery Test.
- **Reset Batt Cap***: Resets the battery capacity calculation.
- **Clr Bad Bat Alm***: Clears a bad battery alarm.
- **Clr LiBatt Lost***: Clears a Li-Ion battery lost alarm.
- **ClrLiBatComFail***: Clears a Li-Ion battery communications fail alarm
- **Clear AbnICur Alm***: Clears an abnormal current alarm.
- **Clear Cur Imb Alm***: Clears a current imbalance alarm.
- **ClrBatTestFail***: Clears a battery test fail alarm.

LVD

LVD Unit Menu

Menu Navigation: Main Menu / Manual / LVD / LVD Unit

Note: For WEB Interface; menu items are found under Device Information / LVD Group / LVD Unit / select the Control tab.

"LVD Unit" Parameter Settings:

- **LVD1 Control:** Temporarily connects or disconnects LVD1. Setting returns to original when Controller is returned to the Auto mode.
- **LVD2 Control:** Temporarily connects or disconnects LVD2. Setting returns to original when Controller is returned to the Auto mode.

EIB

EIB 1 Menu

Menu Navigation: Main Menu / Manual / EIB / EIB1

Note: For WEB Interface; menu items are found under Device Information / EIB Group / EIB 1 / select the Control tab.

"EIB 1" Parameter Settings: (EIB1 refers to the first Extended Interface Board (EIB) in the system.)

- **Relay Output 9 through 13:** Temporarily sets the relay to active or not active. Setting returns to original when Controller is returned to the Auto mode.

Converter

All Conv Ctrl Menu

Menu Navigation: Main Menu / Manual / Converter / All Conv Ctrl

Note: For WEB Interface; menu items are found under Device Information / Converter Group / select the Control tab.

"All Conv Ctrl" Parameter Settings:

- **Converter Trim:** Temporarily sets the output voltage for all converters. Setting reverts to original when Controller is returned to the Auto mode.
- **DC On/Off Ctrl:** Temporarily turns the DC output on or off for all converters. Setting returns to original when Controller is returned to the Auto mode.
- **Conv LED Control:** Temporarily sets whether or not a converter's local power indicator blinks when the Controller is communicating with the converter. Setting returns to original when Controller is returned to the Auto mode.

- **Fan Speed Ctrl:** Temporarily sets the fan speed for all converters. Setting returns to original when Controller is returned to the Auto mode.
- **Confirm ID *:** Confirms the position for all converters.
- **Clear Conv Lost*:** Clears a converter lost alarm.
- **Clear Comm Fail*:** Clears a converter communication fail alarm.
- **ClrAllCommFail*:** Clears all converter communication fail alarms.

Conv #1 Menu

Menu Navigation: Main Menu / Manual / Converter / CONV 1

Note: For WEB Interface; menu items are found under Device Information / Converter Group / Converter #1 / select the Control tab.

"CONV #1" Parameter Settings:

- **DC On/Off Ctrl:** Temporarily turns the converter's DC output on or off. Setting returns to original when Controller is returned to the Auto mode.
- **Over Volt Reset:** Temporarily sets the converter's over voltage reset feature. Setting returns to original when Controller is returned to the Auto mode.
- **LED Control:** Temporarily sets whether or not the converter's local power indicator blinks when the Controller is communicating with the converter. Setting returns to original when Controller is returned to the Auto mode.

SMTemp

SMTemp Group Menu

Menu Navigation: Main Menu / Manual / SMTemp / SMTemp Group

Note: For WEB Interface; menu items are found under Device Information / SM Temp Group / Control Tab.

"SMTemp Group" Parameter Settings:

- **Clr SMTemp Lost*:** Clears an SMTemp lost alarm.

SMTemp # Menu

Menu Navigation: Main Menu / Manual / SMTemp / SMTemp #

Note: For WEB Interface; menu items are found under Device Information / SM Temp Group / SM Temp # / Control Tab.

"SMTemp #" Parameter Settings:

- **Clr Probe Alm*:** Clears an SMTemp probe fail alarm.

3.3.4 Quick Setting Menu

Auto/Manual

Auto/Manual Menu

Menu Navigation: Main Menu / Quick Setting / "Auto/Manual"

Note: For WEB Interface; menu items are found under Quick Settings / "Auto/Manual Setting".

"Auto/Manual" Parameter Settings:

- **Auto/Man State**
 - **Auto:** The Controller automatically controls the power system.

- **Manual:** A User can manually change certain power system control settings via the Manual menu. (See "3.3.3 Manual Menu".) This provides a convenient means of making temporary adjustment changes for testing purposes.

ECO Mode Set

ECO Mode Set Menu

Menu Navigation: Main Menu / Quick Setting / ECO Mode Set

Note: For WEB Interface; menu items are found under Quick Settings / "ECO Mode Setting.

"ECO Mode Set" Parameter Settings:

- **ECO Mode:** Enables or disables the Energy Optimization Mode feature for all rectifiers. When enabled, the following parameters can be set.
 - **Energy Save Pt:** Energy Optimization is disabled if the load is greater than this setting.
 - **Best Oper Point:** Percent of full load capacity that the rectifiers operate under in the Energy Optimization mode.
 - **Fluct Range:** If load fluctuation is less than this value, rectifiers are not turned on or off for Energy Optimization.
 - **Cycle Period:** This is the time period that rectifiers are turned on and off to maintain an equal operating time for all rectifiers in the system.
 - **Rects ON Time:** Time all rectifiers are turned on at End of Cycle.
 - **Turn Off Delay:** When the Energy Optimization feature determines a rectifier can be switched off, this is the time delay before the rectifier is switched off.

FLT/EQ Volts

FLT/EQ Volts Menu

Menu Navigation: Main Menu / Quick Setting / "FLT/EQ Voltag"

Note: For WEB Interface; menu items are found under Quick Settings / "Float/Equalize Charge Voltage".

"FLT/EQ Volts" Parameter Settings:

- **Float Voltage:** Float Charge output voltage setting.
- **EQ Voltage:** Equalize Charge output voltage setting.

FLT/EQ Set

FLT/EQ Set Menu

Menu Navigation: Main Menu / Quick Setting / "FLT/EQ Set"

Note: For WEB Interface; menu items are found under Quick Settings / "Float/Equalize Settings".

"FLT/EQ Set" Parameter Settings:

- **Auto EQ:** Enables or disables the Automatic Equalize Charge feature. When enabled, the following parameters can be set.
 - **EQ Start Curr:** The system is transferred to Equalize Charge mode when battery charge current increases to this setting. For example, a value of 0.060C10 means that an Automatic Equalize is started if the battery charge current is greater than 6% of the battery's nominal capacity.
 - **EQ Start Cap:** The system is transferred to Equalize Charge mode when remaining battery capacity decreases to this setting.
 - **EQ Stop Curr:** When in Equalize Charge mode and the battery charge current decreases below this setting for the "EQ Stop Delay" time period, the system is

transferred to Float Charge mode. For example, a value of 0.010C10 means that when the charging current is less than 1% of the battery's nominal capacity, the system returns to the Float mode.

- **EQ Stop Delay:** See "EQ Stop Curr" above.

Note: *If the power system has been automatically placed in Equalize mode, disabling Auto EQ will **not** return the system to Float mode until the current Equalize cycle is completed. To return immediately to Float mode, navigate as follows: Main Menu / Manual / Batt Group / EQ/FLT Control, and select Float Charge.*

- **Maximum EQ Time:** This is the maximum duration, in minutes, that an Automatic Equalize Charge will last regardless of the other settings.
- **Cyc EQ:** Enables or disables cyclic (scheduled) Equalize charging. When enabled, the following parameters can be set.
 - **Cyc EQ Interval:** Cyclic (scheduled) Equalize charging interval.
 - **Cyc EQ Duration:** Cyclic (scheduled) Equalize charging duration.

Temp Comp

Temp Comp Menu

Menu Navigation: Main Menu / Quick Setting / Temp Comp

Note: For WEB Interface; menu items are found under Quick Settings / Temp Compensation Setting.

"Temp Comp" Parameter Settings:

- **Temp CompCenter:** Sets the temperature at which the system operates at normal voltage levels.
- **Temp Comp Coeff:** Sets the temperature compensation slope or rate of change per °C above or below the "Temp Comp" setting. This value is expressed in millivolt per °C per string (mV/°C/str). For example, for a rate of change of **72 mV/°C/str** in a 24-cell 48V nominal battery string, the rate of change is 3 mV per cell.
- **TempComp Sensor:** Select "None" for no temperature compensation, or the temperature probe (SMTemp8 T8 / ... / SMTemp8 T1 / ... / SMTemp1 T8 / ... / SMTemp1 T1 / EIB T2 / EIB T1 / IB2 T2 / IB2 T1) sensing battery temperature for temperature compensation. You can also select Maximum or Average which takes the maximum or average reading of the temperature probes (any of SMTemp8 T8 / ... / SMTemp8 T1 / ... / SMTemp1 T8 / ... / SMTemp1 T1 / EIB T2 / EIB T1 / IB2 T2 / IB2 T1) set as battery temperature probes. When used with an SM-BRC, you can select to average the SM-BRC temperature probe readings.

Note: *The temperature compensation sensor is also the sensor which displays the battery temperature on the Web Interface's Homepage.*

- **Comp Temp High2:** Allows you to set a high compensation temperature alarm 2 point.
- **Comp Temp High1:** Allows you to set a high compensation temperature alarm 1 point.
- **Comp Temp Low:** Allows you to set a low compensation temperature alarm point.
- **Temp Comp Clamp:** Enables or disables the temperature compensation voltage clamp feature.
- **Temp Comp Max V:** Upper voltage limit where battery temperature compensation clamps the voltage.
- **Temp Comp Min V:** Lower voltage limit where battery temperature compensation clamps the voltage.

Rectifier Expansion

Rectifier Expansion Menu

Up to four (4) ACU+ Controllers can be connected together when a power system requires a greater number of rectifiers than can be controlled by a single ACU+ Controller. One (1) Controller is designated as the primary Controller, the others as secondary Controllers. The rectifiers controlled by the secondary Controllers are designated as RectifierGroup 2 though 4 in the menus.

Primary/Secondary Procedure:

Note: *Changing the Rectifier Expansion setting may take more than 3 minutes for the ACU+ to configure the feature.*

- 1) Connect the ACU+ Controllers in the multiple bays via the RS485 interface.
- 2) Set one of the ACU+ Controllers as the Primary Controller (see below).
- 3) Set all other ACU+ Controllers as Secondary Controllers (see below).
- 4) Set the Address of the ACU+ Controllers set as Secondary Controllers to 201, 202, or 203 (see below). Note that each Secondary Controller must be set to a different address.

Menu Navigation: Main Menu / Quick Setting / Rectifier Expansion

Note: For WEB Interface; menu items are found under Quick Settings / Rectifier Expansion.

"Rectifier Expansion" Parameter Settings:

- **Rect Expansion**
 - **Inactive:** Select this option if this is the only ACU+ Controller in the power system.
 - **Primary:** Select this option if the power system consists of multiple bays with multiple ACU+ Controllers, and this ACU+ Controller is to be the Primary Controller. Note that only one (1) ACU+ Controller can be set as the Primary Controller.
 - **Secondary:** Select this option if the power system consists of multiple bays with multiple ACU+ Controllers, and this ACU+ Controller is to be a Secondary Controller.
- **Address (Slave):** Sets the address of an ACU+ Controller set as a Secondary Controller.

CHAPTER 4. WEB INTERFACE MENUS

4.1 Overview

This section provides descriptions of the WEB Interface Menus. Refer also to “2.2 Passwords and Access Levels” and “2.4 WEB Interface Access”. For parameter descriptions, refer to “3.3 Description of Local Display (and Web Interface) Menu Line Items”. For Local Display Menus, refer to “Chapter 3. Local Display Menus”.

4.2 Homepage

In the WEB Interface, after entering a valid **User Name** and **Password** and clicking **LOGIN**, the "HOMEPAGE" window opens. See also “2.4.6. Logging into the Controller”.

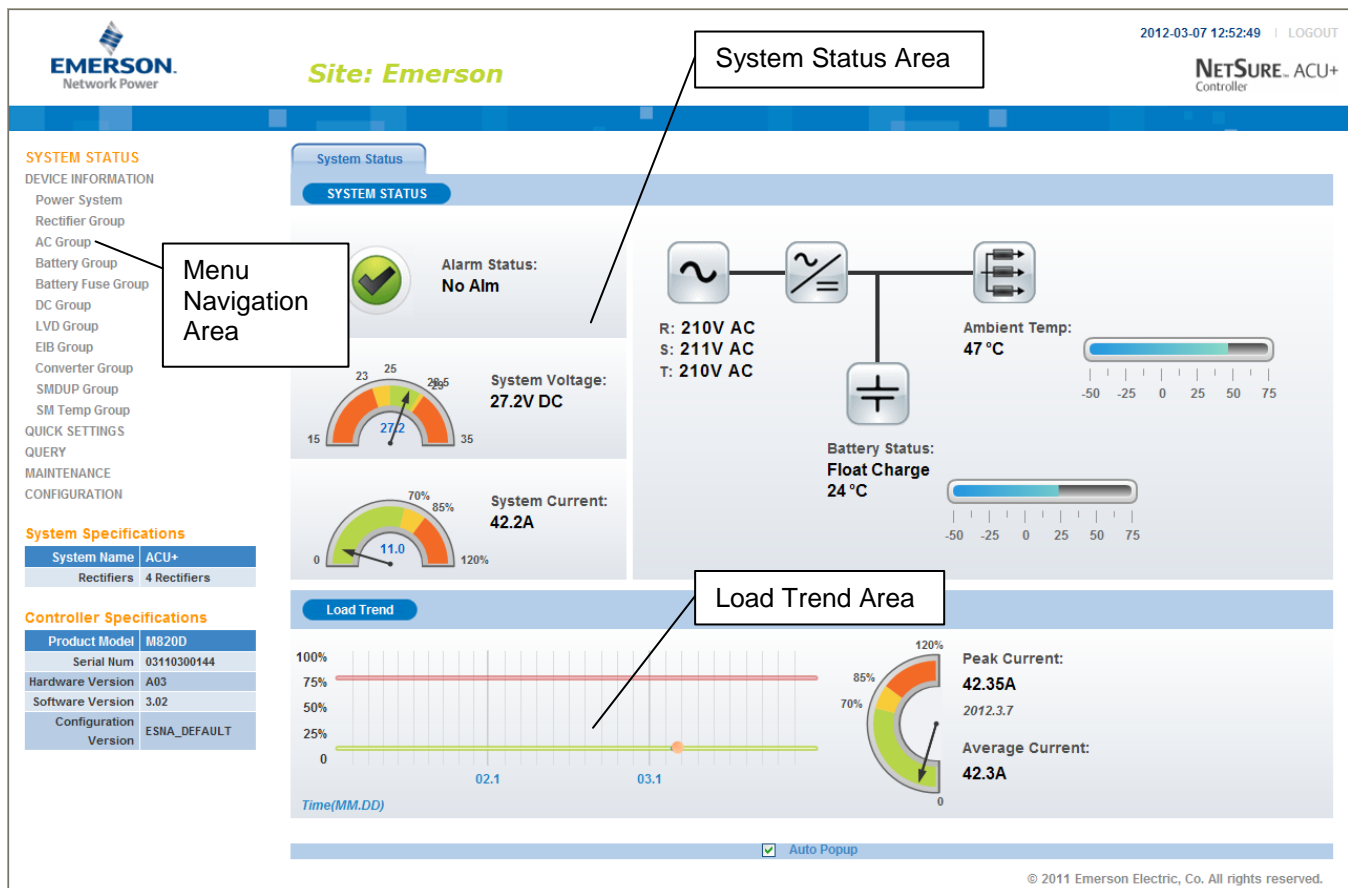

The homepage window is divided into three areas: *System Status*, *Load Trend*, and *Menu Navigation*.

System Status Area

System status is displayed in this area (top right section of Homepage window).

Load Trend Area

A load trend visual is displayed in this area (bottom right section of Homepage window).

Menu Navigation Area

Available menus are displayed in this area (left section of Homepage window).

When you click on a menu name in this area, the menu opens in the right section of the window (replacing the system status and load trend screens).

When the system is in an alarm state, a fourth area (Alarms) appears at the bottom of the display.

Alarms Area

Alarms are displayed in this area (bottom right section of Homepage window).

The screenshot shows the Emerson Network Power web interface for a 'Site: Emerson'. The top right corner displays the date and time '2012-03-07 13:33:19' and a 'LOGOUT' link. The main header includes the Emerson logo and 'NETSURE ACU+ Controller'. The interface is divided into several sections:

- Menu Navigation Area:** A vertical sidebar on the left lists various system components like 'Power System', 'Rectifier Group', 'AC Group', 'Battery Group', etc., and configuration options like 'QUICK SETTINGS' and 'MAINTENANCE CONFIGURATION'.
- System Status Area:** Located at the top center, it features a yellow warning icon and the text 'Alarm Status: Alarm'.
- Device Information:** A central area showing 'System Voltage: 27.3V DC' and 'System Current: 42.4A' with corresponding gauges.
- Temperature Readings:** Two horizontal gauges show 'Ambient Temp: 47 °C' and 'Battery Status: Float Charge 25 °C'.
- Load Trend Area:** A 'Load Trend' button and a scrollable graph showing load percentage over time.
- Alarms Area:** A table at the bottom right listing active alarms.

Index	Alarm Level	Relative Device	Signal Name	Sample Time
1	CR	Power System	DI2 Alarm	2012-03-07 13:32:39
2	CR	Power System	DI1 Alarm	2012-03-07 13:32:16

© 2011 Emerson Electric, Co. All rights reserved.

Temperature Readings

- The temperature sensor set as the “Amb Temp Sensor” in the Power System menu is the sensor which displays the ambient temperature on the Web Interface’s Homepage.
- The temperature compensation sensor is the sensor which displays the battery temperature on the Web Interface’s Homepage.

4.3 Menu Navigation Window

When a menu is clicked on in the left side of the window (menu navigation area), the menu selected is displayed in the top right section of the window (the system status and load trend screens are replaced with a selected menu screen). Note that there is a menu item named SYSTEM STATUS to return to the system status screen.

The screenshot shows the Emerson Network Power web interface. The top navigation bar includes the Emerson logo, 'Site: Emerson', and 'NETSURE ACU+ Controller'. The left sidebar contains a menu with categories like SYSTEM STATUS, DEVICE INFORMATION, and MAINTENANCE. The 'Power System' menu item is highlighted in the top navigation bar, and a callout box labeled 'Selected Menu Area' points to it. The main content area displays a table of system parameters and an 'All Alarms' section below it.



Index	Signal Name	Value	Unit	Sample Time
1	System Voltage	27.1	V	2012-03-07 13:34:48
2	System Load	42.1	A	2012-03-07 13:34:48
3	Maintenance Run Time	144.6	hrs	2012-03-07 13:34:51
4	System Alarm Status	Alarm		2012-03-07 13:34:49
5	Power Split Mode	Master Mode		2012-03-07 12:04:21
6	IB2 Temp2	46.3	deg.C	2012-03-07 13:34:49
7	SMTemp1 Temp1	22.5	deg.C	2012-03-07 13:34:49
8	Digital Input 1	Open		2012-03-07 13:34:50
9	Digital Input 2	Open		2012-03-07 13:34:50
10	Digital Input 3	Open		2012-03-07 13:34:50
11	Digital Input 4	Open		2012-03-07 13:34:50
12	Digital Input 5	Open		2012-03-07 13:34:50
13	Digital Input 6	Open		2012-03-07 13:34:50
14	Digital Input 7	Open		2012-03-07 13:34:50
15	Digital Input 8 ESTOP	Open		2012-03-07 13:34:50

Index	Alarm Level	Relative Device	Signal Name	Sample Time
1	CR	Power System	D12 Alarm	2012-03-07 13:32:39
2	CR	Power System	D11 Alarm	2012-03-07 13:32:16

© 2011 Emerson Electric, Co. All rights reserved.

4.3.1 Alarms

The bottom right section of the window shows any alarms active in the power system.

When viewing the alarms, click the “arrow” icon  to collapse the alarm list. Click the "arrow" icon  again to expand the alarm list. Also located next to the “arrow” icon is a check box named “Auto Popup”. When this box is checked and the alarm window is collapse, a new alarm will cause the alarm window to open.

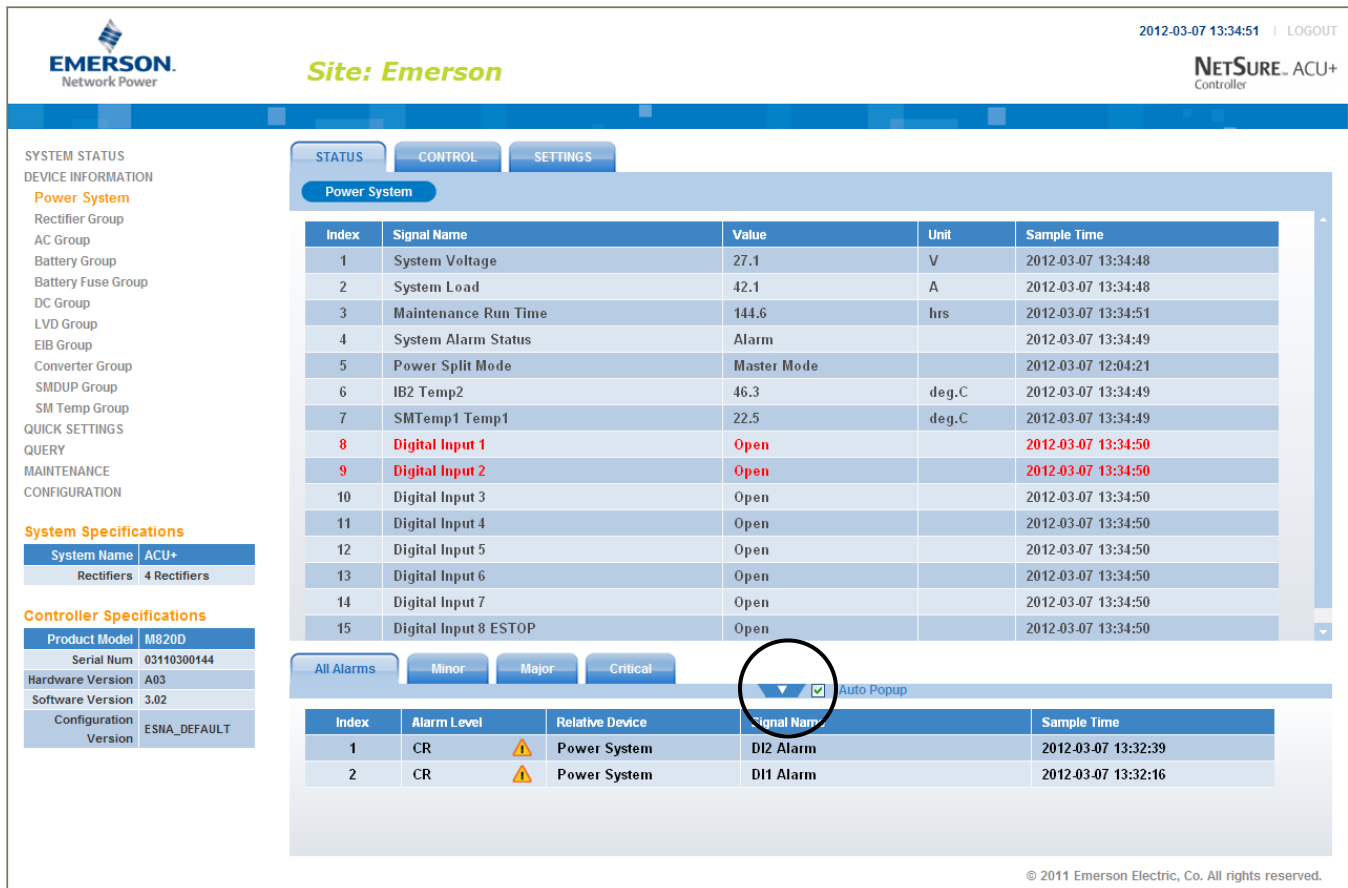

The screenshot displays the Emerson Network Power web interface for a site named "Emerson". The top navigation bar includes the Emerson logo, the site name, and the user's session information (2012-03-07 13:34:51 | LOGOUT). The main content area is divided into several sections:

- SYSTEM STATUS:** Includes tabs for STATUS, CONTROL, and SETTINGS.
- DEVICE INFORMATION:** Lists various system components such as Rectifier Group, AC Group, Battery Group, DC Group, LVD Group, EIB Group, Converter Group, SMDUP Group, and SM Temp Group.
- QUICK SETTINGS, QUERY, MAINTENANCE, CONFIGURATION:** Additional navigation options.
- System Specifications:** Shows details for the ACU+ system, including 4 Rectifiers.
- Controller Specifications:** Lists details for the M820D controller, including Serial Num 03110300144, Hardware Version A03, Software Version 3.02, and Configuration Version ESNA_DEFAULT.
- Power System Table:** A table with columns for Index, Signal Name, Value, Unit, and Sample Time. It lists 15 signals, including System Voltage (27.1 V), System Load (42.1 A), Maintenance Run Time (144.6 hrs), System Alarm Status (Alarm), Power Split Mode (Master Mode), and several Digital Input signals (1-7 are Open, 8-15 are also Open).
- Alarms Section:** Features tabs for All Alarms, Minor, Major, and Critical. A circled "Auto Popup" checkbox is checked. Below this is a table of active alarms:

Index	Alarm Level	Relative Device	Signal Name	Sample Time
1	CR	Power System	D12 Alarm	2012-03-07 13:32:39
2	CR	Power System	D11 Alarm	2012-03-07 13:32:16

© 2011 Emerson Electric, Co. All rights reserved.

The alarms area contains tabs to allow viewing all alarms or a type of alarm (severity). For example, click the Minor tab to display alarms set as Minor alarms.

The screenshot displays the Emerson Network Power web interface for a site named 'Emerson'. The interface includes a navigation menu on the left with sections like SYSTEM STATUS, DEVICE INFORMATION, and MAINTENANCE. The main content area is titled 'Power System' and contains a table of system parameters and an alarm list. The alarm list has tabs for 'All Alarms', 'Minor', 'Major', and 'Critical', with the 'Minor' tab selected. The 'Minor' tab shows two active alarms: 'DI2 Alarm' and 'DI1 Alarm', both with a 'CR' (Critical) level. The 'All Alarms' tab is circled in red in the original image.

System Specifications

System Name	ACU+
Rectifiers	4 Rectifiers

Controller Specifications

Product Model	M820D
Serial Num	03110300144
Hardware Version	A03
Software Version	3.02
Configuration Version	ESNA_DEFAULT

Power System Parameters

Index	Signal Name	Value	Unit	Sample Time
1	System Voltage	27.1	V	2012-03-07 13:34:48
2	System Load	42.1	A	2012-03-07 13:34:48
3	Maintenance Run Time	144.6	hrs	2012-03-07 13:34:51
4	System Alarm Status	Alarm		2012-03-07 13:34:49
5	Power Split Mode	Master Mode		2012-03-07 12:04:21
6	IB2 Temp2	46.3	deg.C	2012-03-07 13:34:49
7	SMTemp1 Temp1	22.5	deg.C	2012-03-07 13:34:49
8	Digital Input 1	Open		2012-03-07 13:34:50
9	Digital Input 2	Open		2012-03-07 13:34:50
10	Digital Input 3	Open		2012-03-07 13:34:50
11	Digital Input 4	Open		2012-03-07 13:34:50
12	Digital Input 5	Open		2012-03-07 13:34:50
13	Digital Input 6	Open		2012-03-07 13:34:50
14	Digital Input 7	Open		2012-03-07 13:34:50
15	Digital Input 8 ESTOP	Open		2012-03-07 13:34:50

Alarms

Index	Alarm Level	Relative Device	Signal Name	Sample Time
1	CR	Power System	DI2 Alarm	2012-03-07 13:32:39
2	CR	Power System	DI1 Alarm	2012-03-07 13:32:16

4.4 Device Information Menu

Listed in this menu are the device groups installed in the system. Click on a device group to view its current or logged operating parameters, set programmable parameters, and change control settings.

The following sections describe the Rectifier and Battery device groups as samples of how to use these menus.

4.4.1 Rectifier Group

The “Rectifier Group” menu contains three tabs: Status, Control, and Settings.

Status Tab

This tab displays the actually sampled values such as “Number of Rectifiers”, “Total Current”, and so on.

2012-03-07 13:37:30 | LOGOUT

EMERSON Network Power *Site: Emerson* **NETSURE** ACU+ Controller

SYSTEM STATUS
DEVICE INFORMATION
Power System
Rectifier Group
Rectifier #1
Rectifier #2
Rectifier #3
Rectifier #4
AC Group
Battery Group
Battery Fuse Group
DC Group
LVD Group
EIB Group
Converter Group
SMDUP Group
SM Temp Group
QUICK SETTINGS
QUERY
MAINTENANCE
CONFIGURATION

System Specifications

System Name	ACU+
Rectifiers	4 Rectifiers

Controller Specifications

Product Model	M820D
Serial Num	03110300144
Hardware Version	A03
Software Version	3.02
Configuration Version	ESNA_DEFAULT

Index	Signal Name	Value	Unit	Sample Time
1	Average Voltage	27.3	V	2012-03-07 13:37:26
2	Total Current	42.3	A	2012-03-07 13:37:26
3	Number of Rectifiers	4		2012-03-07 13:37:28
4	Total Rectifiers Communicating	4		2012-03-07 13:37:26
5	System Capacity Used	11.6	%	2012-03-07 13:37:26
6	Maximum Used Capacity	12.0	%	2012-03-07 13:04:09
7	Minimum Used Capacity	0.0	%	2012-03-07 12:04:21
8	Rated Voltage	24.0	V	2012-03-07 13:37:29
9	AC Phases	Single Phase		2012-03-07 13:37:28
10	Maximum Current Limit Value	462.2	A	2012-03-07 13:37:26
11	Total Rated Current	382.0	A	2012-03-07 13:37:26

Auto Popup

© 2011 Emerson Electric, Co. All rights reserved.

Control Tab

This tab displays the rectifier's control settings and allows you to change these settings. For example, a User can select a value of "Full Speed" for "Fan Speed Control" then click on "Set" to make the rectifier's fan run at full speed. The control command is effective for all the rectifiers.

Note: Settings that appear "grayed out" can only be made when the Controller is in the "manual control" state. If the Controller is set for "automatic" control, change the "Auto/Man State" setting first to the "Man" setting.

2012-03-07 13:37:45 | LOGOUT

EMERSON Network Power Site: Emerson NETSURE ACU+ Controller

SYSTEM STATUS
 DEVICE INFORMATION
 Power System
 Rectifier Group
 Rectifier #1
 Rectifier #2
 Rectifier #3
 Rectifier #4
 AC Group
 Battery Group
 Battery Fuse Group
 DC Group
 LVD Group
 EIB Group
 Converter Group
 SMDUP Group
 SM Temp Group
 QUICK SETTINGS
 QUERY
 MAINTENANCE
 CONFIGURATION

System Specifications

System Name	ACU+
Rectifiers	4 Rectifiers

Controller Specifications

Product Model	M820D
Serial Num	03110300144
Hardware Version	A03
Software Version	3.02
Configuration Version	ESNA_DEFAULT

STATUS CONTROL SETTINGS

Rectifier Group

Index	Signal Name	Value	Unit	Time	Set Value	Set
1	Rectifier Trim (24V)	27.3	V	2012-03-07 13:37:39		Set
2	DC On/Off Control	Switch On All		2012-03-07 13:06:02	Switch On All	Set
3	AC On/Off Control	Switch On All		2012-03-07 13:06:02	Switch On All	Set
4	Rectifiers LED Control	Stop Flashing		2012-03-07 13:36:49	Stop Flashing	Set
5	Fan Speed Control	Automatic Speed	--	--	Automatic Speed	Set
6	Confirm Rectifier ID/Phase	Yes		--	Yes	Set
7	Clear Rectifier Lost Alarm	Yes		--	Yes	Set
8	Reset Cycle Alarm	Clear		--	Clear	Set
9	Clear Rectifier Comm Fail Alarm	Yes		--	Yes	Set

Auto Popup

© 2011 Emerson Electric, Co. All rights reserved.

Settings Tab

This tab displays the rectifier’s programmable settings and allows you to change these settings. For example, a User can select a value of “Disabled” for “Walk-In” then click on “Set” to disable the walk-in function of all the rectifiers.

Note: Settings that appear "grayed out" can only be made when the Controller is in the "manual control" state. If the Controller is set for "automatic" control, change the “Auto/Man State” setting first to the “Man” setting.

2012-03-07 13:38:00 | LOGOUT

EMERSON Network Power Site: Emerson NETSURE ACU+ Controller

SYSTEM STATUS
DEVICE INFORMATION
Power System
Rectifier Group

STATUS CONTROL **SETTINGS**

Index	Signal Name	Value	Unit	Time	Set Value	Set
1	HVSD	Enabled		--	Disabled	Set
2	HVSD Limit (24V)	29.5	V	--		Set
3	Restart on HVSD	Enabled		2012-03-07 12:04:33	Disabled	Set
4	HVSD Restart Time	300	sec	2012-03-07 12:04:33		Set
5	Sequence Start Interval	0	sec	2012-03-07 12:04:33		Set
6	Walk-In	Enabled		2012-03-07 12:04:33	Disabled	Set
7	Walk-In Time	8	sec	2012-03-07 12:04:33		Set
8	Turn On when AC Over Voltage	No		2012-03-07 12:04:33	No	Set
9	ECO Mode	Disabled		--	Disabled	Set
10	Input Current Limit	30.0	A	--		Set
11	MixHE Power	Non-Derated		--	Derated	Set
12	Diesel Generator Power Limit	Disabled		2012-03-06 15:48:59	Disabled	Set
13	Current Limit	Enabled		--	Disabled	Set
14	Current Limit Point	462	A	2012-02-29 16:06:09		Set

Rectifier Group

System Specifications

System Name	ACU+
Rectifiers	4 Rectifiers

Controller Specifications

Product Model	M820D
Serial Num	03110300144
Hardware Version	A03
Software Version	3.02
Configuration Version	ESNA_DEFAULT

Auto Popup

© 2011 Emerson Electric, Co. All rights reserved.

Selecting an Individual Rectifier from the Rectifier Group

Expanding the Rectifier Group menu selection in the left pane lists the individual rectifiers installed in the system in sub-menus. Click on an individual rectifier listed in the sub-menus in the left pane to display its menu screen in the right pane.

The screenshot displays the Emerson Network Power web interface for 'Site: Emerson'. The top right corner shows the date and time '2012-03-07 13:38:20' and a 'LOGOUT' link. The Emerson logo and 'NETSURE ACU+ Controller' branding are visible. The left navigation pane lists various system components, with 'Rectifier #1' selected. The main content area features three tabs: 'STATUS', 'CONTROL', and 'SETTINGS'. Below these is a sub-header 'Rectifier #1' and a table with 12 rows of signal data. At the bottom of the main area, there are two specification tables: 'System Specifications' and 'Controller Specifications'. A footer at the bottom right contains the copyright notice '© 2011 Emerson Electric, Co. All rights reserved.'.

Index	Signal Name	Value	Unit	Sample Time
1	DC Output Voltage	27.2	V	2012-03-07 13:38:19
2	DC Output Current	9.4	A	2012-03-07 13:38:19
3	Temperature	33.1	deg.C	2012-03-07 13:38:19
4	DC Status	On		2012-03-07 13:38:19
5	AC On/Off	On		2012-03-07 13:38:19
6	Valid Rated Current	88.0	A	2012-03-07 13:38:19
7	Walk-In	Enabled		2012-03-07 13:38:19
8	Rectifier ID	1		2012-03-07 13:38:19
9	Rectifier Phase	A		2012-03-07 13:38:19
10	Rectifier SN	01081100015		2012-03-07 13:38:19
11	Total Running Time	3540	hrs	2012-03-07 13:38:19
12	AC Input Voltage	209	V	2012-03-07 13:38:19

System Specifications	
System Name	ACU+
Rectifiers	4 Rectifiers

Controller Specifications	
Product Model	M820D
Serial Num	03110300144
Hardware Version	A03
Software Version	3.02
Configuration Version	ESNA_DEFAULT

An “Individual Rectifier” menu also contains the three tabs: Status, Control, and Settings. The menu items in each of these tabs are specific to the rectifier selected. For example, clicking the Control tab displays the control settings for the selected rectifier.

2012-03-07 13:38:34 | LOGOUT

EMERSON Network Power **Site: Emerson** **NETSURE** ACU+ Controller

SYSTEM STATUS

DEVICE INFORMATION

Power System

Rectifier Group

Rectifier #1

Rectifier #2

Rectifier #3

Rectifier #4

AC Group

Battery Group

Battery Fuse Group

DC Group

LVD Group

EIB Group

Converter Group

SMDUP Group

SM Temp Group

QUICK SETTINGS

QUERY

MAINTENANCE

CONFIGURATION

System Specifications

System Name	ACU+
Rectifiers	4 Rectifiers

Controller Specifications

Product Model	M820D
Serial Num	03110300144
Hardware Version	A03
Software Version	3.02
Configuration Version	ESNA_DEFAULT

STATUS CONTROL SETTINGS

Rectifier #1

Index	Signal Name	Value	Unit	Time	Set Value	Set
1	DC On/Off Control	On		2012-03-07 13:38:34	On	Set
2	AC On/Off Control	On		2012-03-07 13:38:34	On	Set
3	LED Control	Cancel		--	Cancel	Set
4	Rectifier Reset	Reset		--	Reset	Set

Auto Popup

© 2011 Emerson Electric, Co. All rights reserved.

4.4.2 Battery Group (except Li-Ion Battery Configuration)

The “Battery Group” menu contains three tabs: Status, Control, and Settings.

Status Tab

This tab displays the actually sampled values such as “Battery Voltage” and “Total Battery Current”.

2012-03-07 13:39:04 | LOGOUT

EMERSON Network Power

Site: Emerson

NETSURE ACU+ Controller

SYSTEM STATUS

DEVICE INFORMATION

Power System

Rectifier Group

AC Group

Battery Group

Battery 1

Battery Fuse Group

DC Group

LVD Group

EIB Group

Converter Group

SMDUP Group

SM Temp Group

QUICK SETTINGS

QUERY

MAINTENANCE

CONFIGURATION

System Specifications

System Name	ACU+
Rectifiers	4 Rectifiers

Controller Specifications

Product Model	M820D
Serial Num	03110300144
Hardware Version	A03
Software Version	3.02
Configuration Version	ESNA_DEFAULT

STATUS CONTROL SETTINGS

Battery Group

Index	Signal Name	Value	Unit	Sample Time
1	Battery Voltage	27.0	V	2012-03-07 13:38:59
2	Total Battery Current	0	A	2012-03-07 13:38:59
3	Compensation Temperature	26	deg.C	2012-03-07 13:39:03
4	Short BOD Total Time	1	min	2012-03-07 12:05:02
5	Short BOD Counter	5		2012-03-07 12:04:32
6	Long BOD Total Time	0	min	2012-03-07 12:04:53
7	Long BOD Counter	3		2012-03-07 12:04:42
8	Full BOD Total Time	0	min	2012-03-07 12:04:21
9	Full BOD Counter	0		2012-03-07 12:04:21
10	Remaining Time	28.4	hrs	2012-03-07 13:38:59
11	IB2 Temp1	25.5	deg.C	2012-03-07 13:39:03

Auto Popup

© 2011 Emerson Electric, Co. All rights reserved.

Control Tab

This tab displays the battery's control settings and allows you to change these settings. For example, a User can select a value of "Equalize Charge" for "Equalize/Float Charge Control" then click on "Set" to change the charge mode from float to equalize.

Note: Settings that appear "grayed out" can only be made when the Controller is in the "manual control" state. If the Controller is set for "automatic" control, change the "Auto/Man State" setting first to the "Man" setting.

2012-03-07 13:39:24 | LOGOUT

EMERSON Network Power | Site: Emerson | NETSURE ACU+ Controller

SYSTEM STATUS
DEVICE INFORMATION
Power System
Rectifier Group
AC Group
Battery Group
Battery 1
Battery Fuse Group
DC Group
LVD Group
EIB Group
Converter Group
SMDUP Group
SM Temp Group
QUICK SETTINGS
QUERY
MAINTENANCE
CONFIGURATION

System Specifications

System Name	ACU+
Rectifiers	4 Rectifiers

Controller Specifications

Product Model	M820D
Serial Num	03110300144
Hardware Version	A03
Software Version	3.02
Configuration Version	ESNA_DEFAULT

STATUS CONTROL SETTINGS

Battery Group

Index	Signal Name	Value	Unit	Time	Set Value	Set
1	Equalize/Float Charge Control	Float Charge		2012-03-07 12:04:21	Float Charge	Set
2	Battery Test Control	Stop		2012-03-07 12:04:21	Stop	Set
3	Reset Battery Capacity	Yes		--	Yes	Set
4	Clear Bad Battery Alarm	Yes		--	Yes	Set
5	Clear Abnormal Bat Current Alarm	Yes		--	Yes	Set
6	Clear Discharge Curr Imbalance	Yes		--	Yes	Set
7	Clear Battery Test Fail Alarm	Yes		--	Yes	Set

Auto Popup

© 2011 Emerson Electric, Co. All rights reserved.

Settings Tab

This tab displays the battery's programmable settings and allows you to change these settings. For example, a User can select a value of "Yes" for "Automatic Equalize" then click on "Set" to make the setting become effective.

Note: Settings that appear "grayed out" can only be made when the Controller is in the "manual control" state. If the Controller is set for "automatic" control, change the "Auto/Man State" setting first to the "Man" setting.

2012-03-07 13:39:29 | LOGOUT

EMERSON Network Power Site: Emerson NETSURE ACU+ Controller

SYSTEM STATUS
 DEVICE INFORMATION
 Power System
 Rectifier Group
 AC Group
 Battery Group
 Battery 1
 Battery Fuse Group
 DC Group
 LVD Group
 EIB Group
 Converter Group
 SMDUP Group
 SM Temp Group
 QUICK SETTINGS
 QUERY
 MAINTENANCE
 CONFIGURATION

System Specifications

System Name	ACU+
Rectifiers	4 Rectifiers

Controller Specifications

Product Model	M820D
Serial Num	03110300144
Hardware Version	A03
Software Version	3.02
Configuration Version	ESNA_DEFAULT

STATUS CONTROL **SETTINGS**

Battery Group

Index	Signal Name	Value	Unit	Time	Set Value	Set
1	Number of Battery Shunts	1		--	0	Set
2	Calculate Battery Current	No		--	No	Set
3	Low Capacity Point	75	%	--		Set
4	Float Charge Voltage (24V)	27.2	V	--		Set
5	Equalize Charge Voltage (24V)	28.0	V	--		Set
6	Battery Current Limit	0.10	C10	--		Set
7	Over Current Limit	0.30	C10	--		Set
8	Automatic Equalize	No		--	No	Set
9	Maximum Equalize Charge Time	1080	min	--		Set
10	Cyclic Equalize	No		--	No	Set
11	AC Fail Test	Disabled		--	Disabled	Set
12	Constant Current Test	Disabled		--	Disabled	Set
13	Short Test	Disabled		--	Disabled	Set
14	Current Limited	Yes		--	No	Set
15	Charging Efficiency	96	%	--		Set
16	Time to 0.1C10 Discharge Current	10.00	hrs	--		Set
17	Time to 0.2C10 Discharge Current	4.90	hrs	--		Set
18	Time to 0.3C10 Discharge Current	3.00	hrs	--		Set
19	Time to 0.4C10 Discharge Current	2.00	hrs	--		Set
20	Time to 0.5C10 Discharge Current	1.40	hrs	--		Set
21	Time to 0.6C10 Discharge Current	1.20	hrs	--		Set
22	Time to 0.7C10 Discharge Current	1.10	hrs	--		Set
23	Time to 0.8C10 Discharge Current	0.90	hrs	--		Set

Auto Popup

© 2011 Emerson Electric, Co. All rights reserved.

Selecting an Individual Battery String from the Battery Group

Expanding the Battery Group menu selection in the left pane lists the individual battery strings installed in the system in sub-menus. Click on an individual battery string listed in the sub-menus in the left pane to display its menu screen in the right pane.

2012-03-07 13:39:56 | LOGOUT

EMERSON Network Power *Site: Emerson* **NETSURE** ACU+ Controller

SYSTEM STATUS
DEVICE INFORMATION
Power System
Rectifier Group
AC Group
Battery Group
Battery 1
Battery Fuse Group
DC Group
LVD Group
EIB Group
Converter Group
SMDUP Group
SM Temp Group
QUICK SETTINGS
QUERY
MAINTENANCE
CONFIGURATION

System Specifications

System Name	ACU+
Rectifiers	4 Rectifiers

Controller Specifications

Product Model	M820D
Serial Num	03110300144
Hardware Version	A03
Software Version	3.02
Configuration Version	ESNA_DEFAULT

Index	Signal Name	Value	Unit	Sample Time
1	Battery Voltage	27.0	V	2012-03-07 13:39:56
2	Battery Current	0.0	A	2012-03-07 13:39:56
3	Battery Rating (Ah)	300	Ah	2012-03-07 13:39:50
4	Battery Capacity (%)	100.0	%	2012-03-07 13:39:55

Auto Popup

© 2011 Emerson Electric, Co. All rights reserved.

An “Individual Battery String” menu also contains the three tabs: Status, Control, and Settings. The menu items in each of these tabs are specific to the battery string selected. For example, clicking the Settings Tab displays the programmable settings for the selected battery string. Note that if you click the Control tab, nothing will be displayed because the Controller is not allowed to control a single battery string or set the values of a single battery string.

2012-03-07 13:40:09 | LOGOUT

EMERSON Network Power *Site: Emerson* **NETSURE** ACU+ Controller

SYSTEM STATUS
 DEVICE INFORMATION
 Power System
 Rectifier Group
 AC Group
 Battery Group
Battery 1
 Battery Fuse Group
 DC Group
 LVD Group
 EIB Group
 Converter Group
 SMDUP Group
 SM Temp Group
 QUICK SETTINGS
 QUERY
 MAINTENANCE
 CONFIGURATION

System Specifications

System Name	ACU+
Rectifiers	4 Rectifiers

Controller Specifications

Product Model	M820D
Serial Num	03110300144
Hardware Version	A03
Software Version	3.02
Configuration Version	ESNA_DEFAULT

STATUS CONTROL **SETTINGS**

Battery 1

Index	Signal Name	Value	Unit	Time	Set Value	Set
1	Rated Capacity	300.0	Ah	--	<input type="text"/>	Set
2	Shunt Current	150.0	A	--	<input type="text"/>	Set
3	Shunt Voltage	25.0	mV	--	<input type="text"/>	Set

Auto Popup

© 2011 Emerson Electric, Co. All rights reserved.

4.4.3 Battery Group (Li-Ion Battery Configuration)

Status Tab

2008-03-16 04:07:22 | LOGOUT

EMERSON Network Power Site: Emerson NETSURE™ ACU+ Controller

SYSTEM STATUS
DEVICE INFORMATION
Power System
Rectifier Group
AC Group
Battery Group
Li Battery 1
Battery Fuse Group
DC Group
LVD Group
LVD Unit
QUICK SETTINGS
QUERY
MAINTENANCE
CONFIGURATION

System Specifications

System Name	ACU+
Rectifiers	3 Rectifiers

Controller Specifications

Product Model	M820D
Serial Num	03110300144
Hardware Version	A03
Software Version	4.00T04
Configuration Version	552368AA11

Index	Signal Name	Value	Unit	Sample Time
1	Battery Voltage	52.3	V	2008-03-16 04:07:19
2	Total Battery Current	0	A	2008-03-16 04:07:19
3	Short BOD Total Time	4	min	2008-03-15 21:27:49
4	Short BOD Counter	21		2008-03-15 21:27:18
5	Long BOD Total Time	3	min	2008-03-15 21:27:42
6	Long BOD Counter	21		2008-03-15 21:27:24
7	Full BOD Total Time	1	min	2008-03-15 21:27:36
8	Full BOD Counter	17		2008-03-15 21:27:30
9	Remaining Time	360.0	hrs	2008-03-16 04:07:21
10	Li-Ion Group Avg Temperature	21	deg.C	2008-03-16 04:07:19
11	Number of Installed Batteries	1		2008-03-16 04:07:19
12	Number of Disconnected Batteries	0		2008-03-16 04:07:19
13	Number of No Reply Batteries	0		2008-03-16 04:07:19
14	ABCL is active	No		2008-03-16 04:07:21
15	Inventory Update In Process	No		2008-03-16 04:07:19

Auto Popup

© 2012 Emerson Electric Co. All rights reserved.

Control Tab

2008-03-16 04:07:32 | LOGOUT

EMERSON Network Power Site: Emerson NETSURE™ ACU+ Controller

SYSTEM STATUS
DEVICE INFORMATION
Power System
Rectifier Group
AC Group
Battery Group
Li Battery 1
Battery Fuse Group
DC Group
LVD Group
LVD Unit
QUICK SETTINGS
QUERY
MAINTENANCE
CONFIGURATION

System Specifications

System Name	ACU+
Rectifiers	3 Rectifiers

Controller Specifications

Product Model	M820D
Serial Num	03110300144
Hardware Version	A03
Software Version	4.00T04
Configuration Version	552368AA11

Index	Signal Name	Value	Unit	Time	Set Value	Set
1	Clear Li-Ion Battery Lost	Clear		--	Clear	Set
2	Clear Li Battery CommInterrupt	Clear		--	Clear	Set
3	Clear Abnormal Bat Current Alarm	Yes		--	Yes	Set
4	Clear Discharge Curr Imbalance	Yes		--	Yes	Set

Auto Popup

© 2012 Emerson Electric Co. All rights reserved.

Settings Tab

2008-03-16 04:07:37 | LOGOUT

EMERSON Network Power Site: Emerson NETSURE™ ACU+ Controller

SYSTEM STATUS
 DEVICE INFORMATION
 Power System
 Rectifier Group
 AC Group
 Battery Group
 Li Battery 1
 Battery Fuse Group
 DC Group
 LVD Group
 LVD Unit
 QUICK SETTINGS
 QUERY
 MAINTENANCE
 CONFIGURATION

System Specifications
 System Name ACU+
 Rectifiers 3 Rectifiers

Controller Specifications
 Product Model M820D
 Serial Num 03110300144
 Hardware Version A03
 Software Version 4.00T04
 Configuration Version 552368AA11

STATUS CONTROL **SETTINGS**

Battery Group

Index	Signal Name	Value	Unit	Time	Set Value	Set
1	Float Charge Voltage	52.3	V	--	<input type="text"/>	Set
2	Active Battery Current Limit	20	A	--	<input type="text"/>	Set

Auto Popup

© 2012 Emerson Electric Co. All rights reserved.

Individual Battery

2008-03-16 04:08:32 | LOGOUT

EMERSON Network Power Site: Emerson NETSURE™ ACU+ Controller

SYSTEM STATUS
 DEVICE INFORMATION
 Power System
 Rectifier Group
 AC Group
 Battery Group
 Li Battery 1
 Battery Fuse Group
 DC Group
 LVD Group
 LVD Unit
 QUICK SETTINGS
 QUERY
 MAINTENANCE
 CONFIGURATION

System Specifications
 System Name ACU+
 Rectifiers 3 Rectifiers

Controller Specifications
 Product Model M820D
 Serial Num 03110300144
 Hardware Version A03
 Software Version 4.00T04
 Configuration Version 552368AA11

STATUS CONTROL **SETTINGS**

Li Battery 1

Index	Signal Name	Value	Unit	Sample Time
1	Battery Voltage	52.3	V	2008-03-16 04:08:30
2	Battery Current	0.0	A	2008-03-16 04:08:30
3	State of Charge	98.8	%	2008-03-16 04:08:30
4	Battery Terminal Voltage	52.3	V	2008-03-16 04:08:30
5	Cell Temperature	21.0	deg.C	2008-03-16 04:08:30
6	Switch Temperature	21.0	deg.C	2008-03-16 04:08:30
7	Battery LED Status	Full On Green		2008-03-16 04:08:30

Auto Popup

© 2012 Emerson Electric Co. All rights reserved.

4.5 Quick Settings Menu

The various settings presented in the other menus are grouped here by function as a convenient way to program these features.

The screenshot shows the Emerson Network Power web interface. At the top left is the Emerson Network Power logo. The site name 'Site: Emerson' is displayed in green. The top right shows the date and time '2012-03-07 13:40:34' and a 'LOGOUT' link. Below the logo is the 'NETSURE ACU+ Controller' logo.

The left sidebar contains a navigation menu with the following items:

- SYSTEM STATUS
- DEVICE INFORMATION
- QUICK SETTINGS
 - Auto/Manual Setting**
 - ECO Mode Setting
 - Float/Equalize Charge Voltage
 - Float/Equalize Settings
 - Temp Compensation Setting
 - Rectifier Expansion
- QUERY
- MAINTENANCE
- CONFIGURATION

Below the navigation menu are two specification tables:

System Specifications

System Name	ACU+
Rectifiers	4 Rectifiers

Controller Specifications

Product Model	M820D
Serial Num	03110300144
Hardware Version	A03
Software Version	3.02
Configuration Version	ESNA_DEFAULT

The main content area is titled 'Auto/Manual Setting' and contains a table with the following data:

Equipment Name	Signal Name	Value	Unit	Time	Set Value	Set
Power System	Auto/Manual State	Auto		2012-03-07 13:10:09	Auto	Set

At the bottom of the main content area, there is a checkbox labeled 'Auto Popup' which is checked. The footer of the page contains the copyright notice: '© 2011 Emerson Electric, Co. All rights reserved.'

4.6 Query Menu

4.6.1 Alarm History Log Sub-Menu

Select the "Device" to query from the drop-down list box. Enter the "from" and "to" time. Click "Query" to query for alarms within this time slot.

To save the log to your hard drive (in text [.txt] format), click "Upload" and select the path.

The screenshot shows the 'Alarm History Log' sub-menu. On the left, there is a navigation menu with options like SYSTEM STATUS, DEVICE INFORMATION, QUICK SETTINGS, QUERY, Alarm History Log (selected), Data History Log, Control/System/Diesel Log, Battery Test Log, MAINTENANCE, and CONFIGURATION. Below this are sections for System Specifications (System Name: ACU+, Rectifiers: 4 Rectifiers) and Controller Specifications (Product Model: M820D, Serial Num: 03110300144, Hardware Version: A03, Software Version: 3.02, Configuration Version: ESNA_DEFAULT).

The main content area has a header 'Alarm History Log' and search filters:

- Device: All Devices (dropdown)
- From: 2012-03-07 00:00:00
- To: 2012-03-07 23:59:59
- Buttons: Query, Upload

 Below the filters, it states 'Maximum number of records is 500.' and displays a table of alarm records.

Index	Device	Signal Name	Alarm Level	Start Time	End Time
1	Power System	D12 Alarm	CR	2012-03-07 13:32:39	2012-03-07 13:36:46
2	Power System	D11 Alarm	CR	2012-03-07 13:32:16	2012-03-07 13:36:41
3	Power System	D11 Alarm	CR	2012-03-07 13:07:57	2012-03-07 13:09:57
4	DC Fuse Unit	Fuse 8 Alarm	CR	2012-03-07 12:04:22	2012-03-07 12:09:44
5	DC Fuse Unit	Fuse 7 Alarm	CR	2012-03-07 12:04:22	2012-03-07 12:09:41
6	DC Fuse Unit	Fuse 5 Alarm	CR	2012-03-07 12:04:22	2012-03-07 12:09:37
7	DC Fuse Unit	Fuse 4 Alarm	CR	2012-03-07 12:04:22	2012-03-07 12:09:33
8	DC Fuse Unit	Fuse 2 Alarm	CR	2012-03-07 12:04:22	2012-03-07 12:09:30
9	DC Fuse Unit	Fuse 3 Alarm	CR	2012-03-07 12:04:22	2012-03-07 12:09:30
10	DC Fuse Unit	Fuse 1 Alarm	CR	2012-03-07 12:04:22	2012-03-07 12:09:23
11	Power System	SPD	CR	2012-03-07 12:04:22	2012-03-07 12:09:13
12	DC Fuse Unit	Fuse 8 Alarm	CR	2012-03-07 08:44:42	2012-03-07 10:40:13
13	DC Fuse Unit	Fuse 5 Alarm	CR	2012-03-07 08:44:42	2012-03-07 10:40:11
14	DC Fuse Unit	Fuse 7 Alarm	CR	2012-03-07 08:44:42	2012-03-07 10:40:11
15	DC Fuse Unit	Fuse 2 Alarm	CR	2012-03-07 08:44:42	2012-03-07 10:40:08
16	DC Fuse Unit	Fuse 3 Alarm	CR	2012-03-07 08:44:42	2012-03-07 10:40:08
17	DC Fuse Unit	Fuse 4 Alarm	CR	2012-03-07 08:44:42	2012-03-07 10:40:08

At the bottom of the table, there is an 'Auto Popup' checkbox which is checked.

4.6.2 Data History Log Sub-Menu

Select the "Device" to query from the drop-down list box. Enter the "from" and "to" time. Click "Query" to query for data within this time slot.

To save the log to your hard drive (in text [.txt] format), click "Upload" and select the path.

The screenshot displays the 'Data History Log' sub-menu. On the left, there is a navigation menu with categories like SYSTEM STATUS, DEVICE INFORMATION, QUICK SETTINGS, QUERY, MAINTENANCE, and CONFIGURATION. Under the QUERY section, 'Data History Log' is highlighted. Below this, there are sections for 'System Specifications' and 'Controller Specifications' with their respective details.

The main content area features a 'Data History Log' form with the following fields:

- Device Name: All Devices (dropdown)
- Query Type: History (dropdown)
- From: 2012-03-07 00:00:00
- To: 2012-03-07 23:59:59
- Buttons: Query, Upload
- Note: Maximum number of records is 500.

Below the form is a table with the following data:

Index	Device	Signal Name	Value	Unit	Time
1	Power System	System Alarm Status	No Alarm	--	2012-03-07 13:36:50
2	Power System	System Alarm Status	Alarm	--	2012-03-07 13:32:19
3	Power System	System Alarm Status	No Alarm	--	2012-03-07 13:10:00
4	Power System	System Alarm Status	Alarm	--	2012-03-07 13:08:01
5	Power System	System Alarm Status	No Alarm	--	2012-03-07 12:09:46
6	Power System	System Load	42.25	A	2012-03-07 12:04:42
7	Power System	System Voltage	27.21	V	2012-03-07 12:04:42
8	Power System	System Alarm Status	Alarm	--	2012-03-07 12:04:24
9	Power System	System Load	0.00	A	2012-03-07 12:04:21
10	Power System	System Load	42.35	A	2012-03-07 11:58:28
11	Power System	System Voltage	27.22	V	2012-03-07 11:58:23
12	Power System	System Load	0.00	A	2012-03-07 11:58:02
13	Power System	System Load	42.22	A	2012-03-07 11:55:34
14	Power System	System Voltage	27.21	V	2012-03-07 11:55:29
15	Power System	System Load	0.00	A	2012-03-07 11:55:13
16	Power System	System Alarm Status	No Alarm	--	2012-03-07 10:40:15
17	Power System	System Load	42.18	A	2012-03-07 08:45:08
18	Power System	System Voltage	27.23	V	2012-03-07 08:45:03

At the bottom of the table, there is a checkbox for 'Auto Popup' which is checked.

4.6.3 Control/System/Diesel Log Sub-Menu

Select the type of log to query from the drop-down list box. Enter the "from" and "to" time. Click "Query" to query for data within this time slot.

To save the log to your hard drive (in text [.txt] format), click "Upload" and select the path.

The screenshot shows the 'Control/System/Diesel Log' sub-menu. The query form is set to 'Control Log' with a 'From' time of 2012-03-07 00:00:00 and a 'To' time of 2012-03-07 23:59:59. The table below displays 18 log entries with columns for Index, Equipment Name, Signal Name, Control Value, Unit, Control Time, Sender Name, Sender Type, and Control Results.

Index	Equipment Name	Signal Name	Control Value	Unit	Control Time	Sender Name	Sender Type	Control Results
1	Power System	DI2 Alarm State	High	--	2012-03-07 13:36:44	WEB: admin	User	Successful.
2	Power System	DI1 Alarm State	High	--	2012-03-07 13:36:40	WEB: admin	User	Successful.
3	Power System	DI2 Alarm State	Low	--	2012-03-07 13:36:06	WEB: admin	User	Successful.
4	Power System	DI1 Alarm State	Low	--	2012-03-07 13:36:03	WEB: admin	User	Successful.
5	Power System	DI2 Alarm State	Low	--	2012-03-07 13:32:37	WEB: admin	User	Successful.
6	Power System	DI1 Alarm State	Low	--	2012-03-07 13:32:16	WEB: admin	User	Successful.
7	Power System	Auto Manual State	Auto	--	2012-03-07 13:10:09	WEB: admin	User	Successful.
8	Power System	DI1 Alarm State	High	--	2012-03-07 13:09:55	WEB: admin	User	Successful.
9	Power System	DI1 Alarm State	Low	--	2012-03-07 13:07:57	WEB: admin	User	Successful.
10	Power System	Relay 8 Rectifier Alarms	Active	--	2012-03-07 13:07:12	WEB: admin	User	Successful.
11	Power System	Relay 8 Rectifier Alarms	Active	--	2012-03-07 13:06:32	WEB: admin	User	Successful.
12	Power System	Relay 1 Critical Summary	Not Active	--	2012-03-07 13:06:21	WEB: admin	User	Successful.
13	Power System	Relay 1 Critical Summary	Active	--	2012-03-07 13:06:05	WEB: admin	User	Successful.
14	Power System	Auto Manual State	Manual	--	2012-03-07 13:05:53	WEB: admin	User	Successful.
15	Power System	Auto Manual State	Auto	--	2012-03-07 13:05:07	WEB: admin	User	Successful.
16	Power System	Auto Manual State	Manual	--	2012-03-07 13:04:30	WEB: admin	User	Successful.
17	Rectifier #1	AC On/Off Control	On	--	2012-03-07 13:04:15	WEB: admin	User	Successful.
18	Rectifier #1	AC On/Off Control	Off	--	2012-03-07 13:03:42	WEB: admin	User	Successful.

4.6.4 Battery Test Log Sub-Menu

Select the battery test to query from the drop-down list box. Battery test #1 is the most recent. Click “Query” to query for the battery test results.

To save the log to your hard drive (in text [.txt] format), click “Upload” and select the path.

The screenshot shows the 'Battery Test Log' sub-menu. On the left, there is a navigation menu with categories: SYSTEM STATUS, DEVICE INFORMATION, QUICK SETTINGS, QUERY, MAINTENANCE, and CONFIGURATION. Under QUERY, 'Battery Test Log' is highlighted. Below the navigation menu are two specification tables: 'System Specifications' and 'Controller Specifications'. The main content area is titled 'Battery Test Log' and contains a form with a dropdown menu set to '1' and a 'Query' button. At the bottom of the interface, there is an 'Auto Popup' checkbox which is checked, and a copyright notice: '© 2011 Emerson Electric, Co. All rights reserved.'

EMERSON Network Power | Site: Emerson | 2012-03-07 13:42:35 | LOGOUT | NETSURE ACU+ Controller

System Specifications

System Name	ACU+
Rectifiers	4 Rectifiers

Controller Specifications

Product Model	M820D
Serial Num	03110300144
Hardware Version	A03
Software Version	3.02
Configuration Version	ESNA_DEFAULT

Battery Test Log

Choose the last battery test.: 1 Query

Auto Popup

© 2011 Emerson Electric, Co. All rights reserved.

4.7 Maintenance Menu

4.7.1 Network Configuration Sub-Menu

You can configure the Controller's network parameters; such as the IP address, subnet mask, and gateway. After modifying the network parameters, click "Save Parameter" to validate the change made to the parameters.

Note: After changing the IP Address, you will need to login again with the new IP address.

The screenshot shows the Emerson Network Power web interface. At the top, there is a header with the Emerson logo, the site name 'Site: Emerson', and the user information '2012-03-07 13:42:55 | LOGOUT' and 'NETSURE ACU+ Controller'. The left navigation menu includes sections for SYSTEM STATUS, DEVICE INFORMATION, QUICK SETTINGS, QUERY, MAINTENANCE, and CONFIGURATION. Under MAINTENANCE, 'Network Configuration' is highlighted. Under CONFIGURATION, 'System Specifications' and 'Controller Specifications' are listed. The main content area shows the 'Network Configuration' tab, which contains a 'Controller Network Parameter Set' form. The form has three rows: 'Controller Network IP:' with the value '10.201.228.13', 'Subnet Mask:' with the value '255.255.255.0', and 'Gateway:' with the value '10.201.228.1'. Below the form is a 'Save Parameter' button. At the bottom of the page, there is a footer with the copyright notice '© 2011 Emerson Electric, Co. All rights reserved.'

4.7.2 NMS (Network Management System) Configuration Sub-Menu

You can configure the NMS IP, authority, and trap level. You can also add new NMS, modify NMS information, and delete the selected NMS through the interface. You can also set the trap level.

Note: Only listed IP Addresses will have SNMP access.

The screenshot displays the 'NMS Configuration' sub-menu. On the left, a navigation menu lists various system settings, with 'NMS Configuration' highlighted. The main content area features a table with the following structure:

NMS IP	Accepted Trap Level	Public Community	Private Community
<input type="button" value="Add New NMS"/> <input type="button" value="Modify NMS"/> <input type="button" value="Delete NMS"/>			
NMS IP	<input type="text"/>		
Public Community	<input type="text" value="public"/>		
Private Community	<input type="text" value="private"/>		
Change NMS trap alarm level (all current NMS traps will be changed).			
Accepted Trap Level	<input type="text" value="Not Used"/> <input type="button" value="Change Trap"/>		

Below the table, there are 'System Specifications' and 'Controller Specifications' sections. The footer contains the Emerson logo, 'Site: Emerson', the date '2012-03-07 13:43:10', a 'LOGOUT' link, and the 'NETSURE ACU+ Controller' logo. A copyright notice '© 2011 Emerson Electric, Co. All rights reserved.' is also present.

4.7.3 HLMS (High Level Management System) Configuration Sub-Menu

For use with HLMS supporting the YDN23 protocol.

The screenshot displays the HLMS Configuration web interface. At the top, the Emerson Network Power logo and 'Site: Emerson' are visible. The top right corner shows the date and time '2012-03-07 13:43:15' and a 'LOGOUT' link. Below the navigation menu, the 'HLMS Configuration' sub-menu is active. The main configuration area includes the following fields and options:

- Protocol Type:** EEM (dropdown)
- Protocol Media:** Ethernet (dropdown)
- TCP/IP Port Number:** 2000 (text input)
- Self Address:** 1 (text input)
- Callback Enabled:** (checkbox)
- Report Enabled:** (checkbox)
- Alarm Reporting:** (checkbox)
- CCID:** 1 (text input) with Range 1-255
- SOCID:** 1 (text input) with Range 1-20479
- Maximum alarm report attempts:** 3 (text input) with Range 0-255
- Call Elapse Time:** 5 (text input) [s] with Range 0-600
- Main Report Phone Number:** (text input)
- Second Report Phone Number:** (text input)
- Callback Phone Number:** (text input)
- Main Report IP:** (text input)
- Second Report IP:** (text input)
- Security Connection IP 1:** (text input)
- Security Connection IP 2:** (text input)
- Safety Level:** All commands are available. (dropdown)

A 'Modify' button is located at the bottom of the configuration form. The bottom of the page features a copyright notice: '© 2011 Emerson Electric, Co. All rights reserved.'

4.7.4 Edit PowerSplit Sub-Menu

You can configure the PowerSplit parameters and associated digital input signals.

The screenshot shows the 'Edit PowerSplit' sub-menu in the Emerson Network Power web interface. The interface includes a navigation sidebar on the left, a main content area with a table of signals, and system specifications tables.

Navigation Sidebar:

- SYSTEM STATUS
- DEVICE INFORMATION
- QUICK SETTINGS
- QUERY
- MAINTENANCE
 - Network Configuration
 - NMS Configuration
 - HLMS Configuration
 - Edit PowerSplit**
 - User Information Settings
 - Clear Data
 - Restore Factory Defaults
 - Download
 - Retrieve SettingParam.run
 - Time Sync
 - System Inventory
- CONFIGURATION

System Specifications:

System Name	ACU+
Rectifiers	4 Rectifiers

Controller Specifications:

Product Model	M820D
Serial Num	03110300144
Hardware Version	A03
Software Version	3.02
Configuration Version	ESNA_DEFAULT

Main Content Area:

Edit PowerSplit

PowerSplit Mode: MASTER :

Signal Name	Equipment Name	Signal Type	Signal Name	Edit
LVD1	NA	NA	NA	<input type="button" value="Edit"/>
LVD2	NA	NA	NA	<input type="button" value="Edit"/>
LVD3	NA	NA	NA	<input type="button" value="Edit"/>
BATTERY_TEST	NA	NA	NA	<input type="button" value="Edit"/>
EQUALIZE_CHARGE	NA	NA	NA	<input type="button" value="Edit"/>

Other PowerSplit setting signals are here. [Power System](#)

Auto Popup

© 2011 Emerson Electric, Co. All rights reserved.

4.7.5 User Information Settings Sub-Menu

You can add, edit, and delete Users. These are the Users that can log onto the Controller both locally (local display access) or remotely using the Web Interface.

The screenshot displays the Emerson Network Power web interface. The top navigation bar includes the Emerson logo, the site name 'Site: Emerson', and the controller model 'NETSURE.. ACU+ Controller'. The date and time '2012-03-07 13:43:41' and a 'LOGOUT' link are also visible. The left sidebar contains a navigation menu with categories like SYSTEM STATUS, DEVICE INFORMATION, and MAINTENANCE. The main content area is titled 'User Information Settings' and features a 'WEB User Management' section. This section includes a table of 'Current Users' with columns for 'User Name' and 'Authority'. Below the table are buttons for 'Add New User', 'Modify User', and 'Delete Selected User'. There are also input fields for 'User Name', 'Password', 'Confirm', and a dropdown for 'Authority'. The footer of the page contains the copyright notice '© 2011 Emerson Electric, Co. All rights reserved.'

Adding a User

- 1) Enter the User's Name in the "User Name" field (13 characters maximum; the valid characters are 0-9, a-z, A-Z, and _).
- 2) Select the authority of the User from those listed in the "Authority" drop-down list box. See "User Authority Level" below for a description.
- 3) Enter a password for this User in the "Password" field (13 characters maximum; the valid characters are 0-9, a-z, A-Z, and _).
- 4) Re-enter the password for this User in the "Confirm" field.
- 5) Click the "Add New User" button to add the User.

Modifying an Existing User

- 1) Select the User to be modified from those listed in the "Current Users" list.
- 2) Modify the parameters of this User in the "User Name", "Authority", and/or "Password" field.
- 3) Click the "Modify User" button to modify the parameters of this User.

Deleting a User

- 1) Select the User to be deleted from those listed in the "Current Users" list.
- 2) Click the "Delete Selected User" button to delete this User.

User Authority Level

A User is assigned one of the following "Authority Levels".

Each Authority Level gives a User access to specific menus. A User has access to his/her level menus, plus all menus of the lesser authority levels.

Authority Level	User Authority
Browser	The User can only read (browse) information in the menus.
Operator	The User has access to the system "Control" menus.
Engineer	The User has access to the system "Setting" menus and can download the configuration file.
Administrator	The User has full access to all menus; including update the OS application and modifying, adding, and deleting Users.

4.7.6 Clear Data Sub-Menu

Select the data log to be cleared from those listed in the drop-down list box. Click on the “Clear” button to clear the corresponding data.

The screenshot shows the Emerson Network Power web interface. At the top left is the Emerson Network Power logo. At the top right, it displays the date and time '2012-03-07 13:43:56' and a 'LOGOUT' link. Below the logo is the text 'Site: Emerson' and the 'NETSURE ACU+ Controller' logo. The left navigation menu includes categories like SYSTEM STATUS, DEVICE INFORMATION, QUICK SETTINGS, QUERY, MAINTENANCE, and CONFIGURATION. The 'Clear Data' sub-menu is active, showing a 'Clear:' label, a dropdown menu currently set to 'Alarm History', and a 'Clear' button. Below the navigation menu, there are two tables: 'System Specifications' and 'Controller Specifications'.

System Name	ACU+
Rectifiers	4 Rectifiers

Product Model	M820D
Serial Num	03110300144
Hardware Version	A03
Software Version	3.02
Configuration Version	ESMA_DEFAULT

4.7.7 Restore Factory Defaults Sub-Menu

To return all configuration values to their factory default values, click on the “Restore Defaults” button. Click “OK” to confirm to overwrite the existing configuration files with the factory default configuration files.

For the default settings to become effective, the Controller must be rebooted. Click on the “Reboot Controller” button to reboot the Controller.

Warning: When you restore defaults, the Controller’s existing configuration and parameter settings will be lost.

The screenshot shows the Emerson Network Power web interface. At the top left is the Emerson Network Power logo. The site name 'Site: Emerson' is displayed in green. The top right shows the date and time '2012-03-07 13:44:06' and a 'LOGOUT' link. Below the logo is the 'NETSURE ACU+ Controller' logo. The left navigation menu includes categories like SYSTEM STATUS, DEVICE INFORMATION, QUICK SETTINGS, QUERY, MAINTENANCE, and CONFIGURATION. The 'Restore Factory Defaults' option is highlighted in orange. Below the navigation menu are two tables: 'System Specifications' and 'Controller Specifications'. The main content area is titled 'Restore Factory Defaults' and contains a confirmation dialog box with the text 'Restore default configuration? The system will reboot.' and two buttons: 'Restore Defaults' and 'Reboot Controller'. At the bottom right of the main content area, there is a checkbox labeled 'Auto Popup' which is checked. The footer of the page contains the copyright notice '© 2011 Emerson Electric, Co. All rights reserved.'

System Specifications	
System Name	ACU+
Rectifiers	4 Rectifiers

Controller Specifications	
Product Model	M820D
Serial Num	03110300144
Hardware Version	A03
Software Version	3.02
Configuration Version	ESNA_DEFAULT

4.7.8 Download Sub-Menu

You can download (from your hard drive into the Controller) a configuration package, application ("All") package, or language package (filename of each has a tar or tar.gz extension). You can also download the file "SettingParam.run (see "4.7.9 Retrieve 'SettingParam.run' File Sub-Menu" for a description)".

You can upload (from the Controller to your hard drive) a configuration package or language package.

To download a file, you need to shut down the Controller first. When you select the "Download" submenu, the "Stop Controller" window opens. Click on the "Stop Controller" button.

The screenshot shows the Emerson Network Power web interface. At the top left is the Emerson Network Power logo. The site name "Site: Emerson" is displayed in green. The top right shows the date and time "2012-03-07 13:44:17" and a "LOGOUT" link. Below the logo is the "NETSURE ACU+ Controller" logo. The left sidebar contains a navigation menu with categories: SYSTEM STATUS, DEVICE INFORMATION, QUICK SETTINGS, QUERY, MAINTENANCE, and CONFIGURATION. Under MAINTENANCE, the "Download" option is highlighted in orange. Below the menu are two tables: "System Specifications" and "Controller Specifications". The "Download" option is highlighted in orange. The main content area shows a "Download" button at the top. Below it, a "Stop Controller" dialog box is open, displaying the message "Download needs to stop the Controller. Do you want to stop the Controller?" and a "Stop Controller" button.

System Name	ACU+
Rectifiers	4 Rectifiers

Product Model	M820D
Serial Num	03110300144
Hardware Version	A03
Software Version	3.02
Configuration Version	ESNA_DEFAULT

The following window opens.

Warning: *Never navigate from this web page without first clicking on "Start Controller". If you do, you will not have web access. A manual system reset is required to restore web access.*

- To download a package or a "SettingParam.run" file, click the "Browse..." button and navigate to the folder where the file to download is located. Select the file to be downloaded and then click the "Download" button. Click "Start Controller" to restart the Controller with the downloaded file installed.
- To upload a file, select "Configuration Package" or "Language Package" from the "File in Controller" drop-down list box, and click on the "Upload" button to save the file to your computer.

Note: *Configuration Package is a package of files containing all the default parameter settings and the current settings for relay severity and relay assignments.*

Note: *Language Package is a package of files containing all the default names of the parameters.*

Note: *See "4.7.9 Retrieve 'SettingParam.run' File Sub-Menu" for a description of the "SettingParam.run" file.*

EMERSON Network Power | Site: Emerson | 2012-03-07 13:44:36 | LOGOUT | NETSURE ACU+ Controller

Download

Download File

Caution: Only the file package of tar and tar.gz can be downloaded. If the downloaded file is NOT correct, the Controller will run abnormally. The Controller must be restarted manually after download.

Select File

File in Controller Configuration Package

System Specifications

System Name	ACU+
Rectifiers	4 Rectifiers

Controller Specifications

Product Model	M820D
Serial Num	03110300144
Hardware Version	A03
Software Version	3.02
Configuration Version	ESNA_DEFAULT

Auto Popup

© 2011 Emerson Electric, Co. All rights reserved.

4.7.9 Retrieve 'SettingParam.run' File Sub-Menu

A file, named "SettingParam.run", is automatically created by the Controller whenever a User makes changes to any parameter settings via the LCD or WEB interface.

You can upload a "SettingParam.run" file into your computer and then download the file to another Controller (refer to "4.7.8 Download Sub-Menu"), so that other Controllers can have the same parameters.

Click on the "Retrieve File" button to save the file named "SettingParam.run" to you hard drive.

Note: *It is strongly recommended that you save a copy of the "SettingParam.run" file whenever you customize any parameter settings. Then, if you ever replace the Controller or perform a "Reload Config" procedure, you can restore your customized settings by downloading the previously saved "SettingParam.run" file back into the Controller.*

Note: *Ensure Internet Explorer security settings are set to enable a file to be downloaded.*

To aid in file management, you may change the name of the "SettingParam.run" file. The new name can use alpha and numeric characters preceding the original "SettingParam.run" name (the end of the new file name **must** always be "SettingParam.run"; for example, an acceptable filename would be "seville4SettingParam.run").

The screenshot displays the Emerson Network Power web interface. At the top left is the Emerson Network Power logo. The site name "Site: Emerson" is centered at the top. On the top right, the date and time "2012-03-07 13:44:36" and a "LOGOUT" link are visible. Below the site name, the "NETSURE ACU+ Controller" logo is present. The left sidebar contains a navigation menu with categories: SYSTEM STATUS, DEVICE INFORMATION, QUICK SETTINGS, QUERY, MAINTENANCE, and CONFIGURATION. Under MAINTENANCE, "Retrieve SettingParam.run" is highlighted in orange. Under CONFIGURATION, there are two tables: "System Specifications" and "Controller Specifications".

System Specifications	
System Name	ACU+
Rectifiers	4 Rectifiers

Controller Specifications	
Product Model	M820D
Serial Num	03110300144
Hardware Version	A03
Software Version	3.02
Configuration Version	ESMA_DEFAULT

The main content area features a sub-menu titled "Retrieve SettingParam.run". Below this, a box contains the text "Retrieve 'SettingParam.run' File:" and "Retrieve the current settings of the Controller's adjustable parameters." A "Retrieve File" button is located at the bottom of this box. At the bottom of the page, there is an "Auto Popup" checkbox which is checked, and a copyright notice: "© 2011 Emerson Electric, Co. All rights reserved."

4.7.10 Time Sync Sub-Menu

Use the "Time Sync" submenu to set the Controller's clock. Click "Get Local Zone" to obtain the time zone from the local host. Click "Get Local Time" to obtain the time from the local host. Click the "Setting" button to update the Controller's time.

The screenshot displays the Emerson Network Power web interface. At the top, the Emerson logo is on the left, the site name "Site: Emerson" is in the center, and the date "2012-03-07 13:51:34" and "LOGOUT" link are on the right. Below the header is a blue navigation bar. On the left side, there is a vertical menu with categories: SYSTEM STATUS, DEVICE INFORMATION, QUICK SETTINGS, QUERY, MAINTENANCE, and CONFIGURATION. Under MAINTENANCE, "Time Sync" is highlighted. Under CONFIGURATION, "System Specifications" and "Controller Specifications" are listed. The main content area shows the "Time Sync" sub-menu with a "Time Setting" form. The form has two radio buttons: "Get time automatically from the following time servers." (unselected) and "Specify Time" (selected). The "Specify Time" section includes a "Get Local Time" button, a "Date" field with value "2012/03/07", and a "Time" field with value "13:51:43". A "Setting" button is at the bottom of the form. At the bottom of the page, there is a footer with "© 2011 Emerson Electric, Co. All rights reserved." and an "Auto Popup" checkbox.

4.7.11 System Inventory Sub-Menu

The “System Inventory” submenu allows you to view the product revision, serial number, and software revision information of the intelligent devices (such as rectifier, SMDU, and IB board) connected to the Controller.

The screenshot displays the Emerson Network Power web interface. At the top right, it shows the date and time '2012-03-07 13:51:48' and a 'LOGOUT' link. The site name 'Site: Emerson' is prominently displayed. The left sidebar contains a navigation menu with categories like SYSTEM STATUS, DEVICE INFORMATION, QUICK SETTINGS, QUERY, MAINTENANCE, and CONFIGURATION. The 'System Inventory' option is highlighted in orange. Below this, there are sections for 'System Specifications' and 'Controller Specifications', each with a table of key-value pairs. The main content area features a 'System Inventory' tab and a table listing various equipment components with their respective models, revisions, serial numbers, and software versions. At the bottom right of the main area, there is an 'Auto Popup' checkbox which is checked.

Equipment	Product Model	Product Revision	Serial Number	Software Revision
ACU+	M820D	A03	03110300144	3.02
Rectifier #1	1R242500	A03	01081100015	1.05
Rectifier #2	1R243000	A00	01101201372	3.03
Rectifier #3	1R243000	A00	01101201402	3.03
Rectifier #4	1R242500	A05	01110305774	1.05
EIB 1	1MA455U41	A01	03110300004	1.02
IB 1	1MA4C5U31	A01	03100100080	1.02
SMDUP 1	1SMDU+	A00	03190500011	1.20
Converter #1	1C24481500	B03	01100901079	0.03
Converter #2	1C24481500	B03	01100105306	0.03
Converter #3	1C24481500	B03	01100105308	0.03
SM Temp 1	-TEMP	A01	SM100900002	2.00

4.8 Configuration Menu

4.8.1 Auto Configuration Sub-Menu

The auto configuration feature scans the system for intelligent equipment connected to the Controller (such as SMDU, IB, and EIB) and configures these into the Controller automatically.

To start the auto configuration process, click on the "Auto Configuration" button.

The screenshot displays the Emerson Network Power web interface. At the top left is the Emerson Network Power logo. The site name "Site: Emerson" is centered at the top. On the top right, the date and time "2012-03-07 13:53:20" and a "LOGOUT" link are visible. Below the site name, the "NETSURE ACU+ Controller" logo is present. The left sidebar contains a navigation menu with categories: SYSTEM STATUS, DEVICE INFORMATION, QUICK SETTINGS, QUERY, MAINTENANCE, CONFIGURATION, and System Specifications. Under CONFIGURATION, "Auto Configuration" is highlighted in orange. Below it are links for Site Info Modification, Equipment Info Modification, Signal Information Modification, Alarm Suppression, PLC, and Alarm Relays. The System Specifications section contains two tables. The first table shows System Name as ACU+ and Rectifiers as 4 Rectifiers. The second table, Controller Specifications, shows Product Model as M820D, Serial Num as 03110300144, Hardware Version as A03, Software Version as 3.02, and Configuration Version as ESNA_DEFAULT. The main content area is titled "Auto Configuration" and contains a blue box with the text "Auto Configuration: This function allows a User to automatically configure the controller." and an "Auto Configuration" button. At the bottom of the main area, there is a checkbox labeled "Auto Popup" which is checked. The footer of the page contains the copyright notice "© 2011 Emerson Electric, Co. All rights reserved."

4.8.2 Site Information Modification Sub-Menu

Here you can add or change Site information. You can enter information such as a site name, site location, and site description. Click on the "Set" button to store the Site information entered. After you change the Site information you will need to reboot the controller to see the changes.

The screenshot shows the Emerson Network Power web interface. At the top left is the Emerson Network Power logo. At the top center, it says "Site: Emerson". At the top right, it shows the date and time "2012-03-07 13:53:31" and a "LOGOUT" link. Below the logo is the "NETSURE ACU+ Controller" logo.

The left sidebar contains a navigation menu with the following items: SYSTEM STATUS, DEVICE INFORMATION, QUICK SETTINGS, QUERY, MAINTENANCE, CONFIGURATION, Auto Configuration, **Site Info Modification** (highlighted), Equipment Info Modification, Signal Information Modification, Alarm Suppression, PLC, Alarm Relays, **System Specifications**, and **Controller Specifications**.

The main content area is titled "Site Info Modification" and contains a table with the following data:

Device Name	Signal Name	Value	Setting Value	Set
Site	Site Name	ACU+	<input type="text"/>	<input type="button" value="Set"/>
Site	Site Location	Emerson	<input type="text"/>	<input type="button" value="Set"/>
Site	Site Description	ACU+	<input type="text"/>	<input type="button" value="Set"/>

Below the table, there is a checkbox labeled "Auto Popup" which is checked.

At the bottom right of the page, it says "© 2011 Emerson Electric, Co. All rights reserved."

4.8.3 Equipment Information Modification Sub-Menu

Here you can change the name of an equipment device connected to the Controller. Equipment devices have two names. One is the "Device Full Name" and another is the "Device Abbreviated Name". The "Device Full Name" is displayed in the WEB Interface menus and the "Device Abbreviated Name" is displayed in the local LCD display menus.

Enter the new device name in the "New Device Name" column and select what Device Name is to be changed ("Device Full Name" or "Device Abbreviated Name"). Click on the "Set" button to save the new name.

Device Full Name (32 characters maximum).

Device Abbreviated Name (15 characters maximum).

2012-03-07 13:54:03 | LOGOUT

EMERSON Network Power Site: Emerson NETSURE ACU+ Controller

SYSTEM STATUS
DEVICE INFORMATION
CONFIGURATION
Equipment Info Modification

Index	Device Name	Device Abbreviated Name	New Device Name	Modify Name Type	Set
1	Power System	Power System		Full Name	Set
2	Rectifier Group	Rect Group		Full Name	Set
3	Rectifier #1	Rect #1		Full Name	Set
4	Rectifier #2	Rect #2		Full Name	Set
5	Rectifier #3	Rect #3		Full Name	Set
6	Rectifier #4	Rect #4		Full Name	Set
7	AC Group	AC Group		Full Name	Set
8	Rectifier AC	Rect AC		Full Name	Set
9	OB AC Unit	OB AC Unit		Full Name	Set
10	SMDU Group	SMDU Group		Full Name	Set
11	SMDU 1	SMDU 1		Full Name	Set
12	SMDU 2	SMDU 2		Full Name	Set
13	SMDU 3	SMDU 3		Full Name	Set
14	SMDU 4	SMDU 4		Full Name	Set
15	SMDU 5	SMDU 5		Full Name	Set
16	SMDU 6	SMDU 6		Full Name	Set
17	SMDU 7	SMDU 7		Full Name	Set
18	SMDU 8	SMDU 8		Full Name	Set
19	Battery Group	Batt Group		Full Name	Set
20	Battery 1	Battery 1		Full Name	Set
21	Battery 2	Battery 2		Full Name	Set
22	EIB1Battery 1	EIB1Batt 1		Full Name	Set
23	EIB1Battery 2	EIB1Batt 2		Full Name	Set

System Specifications
System Name ACU+
Rectifiers 4 Rectifiers

Controller Specifications
Product Model M820D
Serial Num 03110300144
Hardware Version A03
Software Version 3.02
Configuration Version ESNA_DEFAULT

Auto Popup

© 2011 Emerson Electric, Co. All rights reserved.

4.8.4 Signal Information Modification Sub-Menu

Here you can change the name of signals connected to the Controller. Signals have two names. One is the “Signal Full Name” and another is the “Signal Abbreviated Name”. The “Signal Full Name” is displayed in the WEB Interface menus and the “Signal Abbreviated Name” is displayed in the local LCD display menus.

Enter the new signal name in the “New Name” column and select what Name is to be changed (“Signal Full Name” or “Signal Abbreviated Name”). Click on the “Set” button to save the new name.

Signal Full Name (32 characters maximum).

Signal Abbreviated Name (15 characters maximum).

Note: *If a signal is renamed it is recommended to retain enough information about the physical location of the signal as possible. As an example, if you want to assign a name of 'Intrusion 6' to the signal who's default name is 'DI1 Alarm' it could be labeled 'DI1 Intrusion 6'. This will help in physically locating the wiring etc. related to the 'Intrusion 6' alarm. Alternately, the customer could label the wiring and/or position that is related to the signal name.*

2012-03-07 13:54:06 | LOGOUT

EMERSON Network Power Site: Emerson NETSURE ACU+ Controller

SYSTEM STATUS
 DEVICE INFORMATION
 QUICK SETTINGS
 QUERY
 MAINTENANCE
 CONFIGURATION
 Auto Configuration
 Site Info Modification
 Equipment Info Modification
Signal Information Modification
 Alarm Suppression
 PLC
 Alarm Relays

System Specifications
 System Name ACU+
 Rectifiers 4 Rectifiers

Controller Specifications
 Product Model M820D
 Serial Num 03110300144
 Hardware Version A03
 Software Version 3.02
 Configuration Version ESNA_DEFAULT

Signal Information Modification

Query Device Type Power System
 Signal Type Sample Signal

Index	Signal Full Name	Signal Abbreviated Name	New Name	Modify Type	Set
1	System Voltage	System Voltage		Full Name	Set
2	System Load	System Load		Full Name	Set
3	Maintenance Run Time	Mtnc Run Time		Full Name	Set
4	System Alarm Status	Alarm Status		Full Name	Set
5	Power Split Mode	Power Split		Full Name	Set
6	System Temp1	System T1		Full Name	Set
7	System Temp2	System T2		Full Name	Set
8	System Temp3	System T3		Full Name	Set
9	IB2 Temp1	IB2 T1		Full Name	Set
10	IB2 Temp2	IB2 T2		Full Name	Set
11	EIB Temp1	EIB T1		Full Name	Set
12	EIB Temp2	EIB T2		Full Name	Set
13	SMTemp1 Temp1	SMTemp1 T1		Full Name	Set
14	SMTemp1 Temp2	SMTemp1 T2		Full Name	Set
15	SMTemp1 Temp3	SMTemp1 T3		Full Name	Set
16	SMTemp1 Temp4	SMTemp1 T4		Full Name	Set
17	SMTemp1 Temp5	SMTemp1 T5		Full Name	Set
18	SMTemp1 Temp6	SMTemp1 T6		Full Name	Set
19	SMTemp1 Temp7	SMTemp1 T7		Full Name	Set

Auto Popup

© 2011 Emerson Electric, Co. All rights reserved.

Sample Signal Name Modification Procedure

The following procedure demonstrates how to change the “System Voltage” to “Bus Voltage”.

- 1) Select the equipment to which this signal belongs: Power System.
- 2) Select the signal type to which the signal belongs: Sample Signal.
- 3) Enter new signal name: Bus Voltage.

- 4) Select the type of signal name to be changed: "Signal Full Name" or "Signal Abbreviated Name".
- 5) Click the "Set" button.

For alarm signals, you can also change the alarm level (severity) for the alarm signal.

In the second step in the above procedure, select "Alarm Signal", then the alarm signal name and alarm level are displayed. Select "New alarm level" and click "Set" to change the alarm level (severity) of this alarm signal.

4.8.5 Alarm Suppressing Sub-Menu

Here you can modify the Alarm Suppression relationships of an alarm signal.

Alarm Suppression Explanation: If Alarm A suppresses Alarm B, when Alarm A occurs, Alarm B will not be reported even if the conditions of Alarm B are met. For example, AC failure alarm will suppress AC low voltage alarm. When AC failure occurs, the alarm conditions for both AC failure alarm and AC low voltage alarm are met, and both alarms should be reported. However, since the AC failure alarm suppresses the AC low voltage alarm, only AC failure alarm is displayed in the alarm list.

To configure Alarm Suppression, first select the device to which the alarm signal belongs. This displays all the alarm signals of this device.

Locate the alarm signal to be configured for Alarm Suppression and click on the “Modify” button for this alarm signal.

The screenshot shows the 'Alarm Suppression' configuration page in the Emerson Network Power web interface. The page title is 'Site: Emerson'. The main content area features a table of alarm signals with columns for 'Alarm Signal ID', 'Alarm Signal Name', 'Alarm Suppression Expression', and 'Modify'. A dropdown menu is visible above the table, labeled 'Please select standard equipment:'. The table lists 25 alarm signals, each with a 'Modify' button. The 'Modify' button for the last row is partially obscured by an 'Auto Popup' checkbox.

Alarm Signal ID	Alarm Signal Name	Alarm Suppression Expression	Modify
1	Supervision Unit Fault	NA	Modify
2	CAN Communication Failure	NA	Modify
10	Outgoing Alarms Blocked	NA	Modify
11	Maintenance Time Limit Alarm	NA	Modify
13	Config Error(Backup Config)	NA	Modify
14	Config Error(Default Config)	NA	Modify
15	Imbalance System Current	NA	Modify
16	Over Load	NA	Modify
40	SPD	NA	Modify
41	EStop/EShutdown	NA	Modify
18	System Temp 1 Not Used	NA	Modify
19	System Temp 2 Not Used	NA	Modify
20	System Temp3 Not Used	NA	Modify
21	IB2 Temp 1 Not Used	[IB,Communication Fail]	Modify
22	IB2 Temp2 Not Used	[IB,Communication Fail]	Modify
42	EIB Temp1 Not Used	[EIB,EIB Communication Fail]	Modify
43	EIB Temp2 Not Used	[EIB,EIB Communication Fail]	Modify
9	System Temp 1 Sensor Fault	[Power System,System Temp 1 Not Used]	Modify
25	System Temp 2 Sensor Fault	[Power System,Custom Temp 2 Not Used]	Modify

The following screen appears which allows you to configure the Alarm Suppression Expression. In this screen, you can select the signals in the Alarm Suppression Expression and enter the logic relationship before the alarm signal (Logic AND &, Logic OR |, Logic NO!).

The screenshot shows the 'Alarm Suppression' configuration page in the Emerson Network Power web interface. The page header includes the Emerson logo, 'Site: Emerson', and the date/time '2012-03-07 13:55:08 | LOGOUT'. The main content area is titled 'Alarm Suppression' and contains the following configuration options:

- How many signals are there in the Alarm Suppression Expression:** A dropdown menu set to '2'.
- Alarm Suppression Expression:** Two rows of dropdown menus. The first row shows 'Rectifier Group' and 'Multiple Rectifiers Failure'. The second row shows '&' (Logic AND) and 'Rectifier Group' and 'Multiple Rectifiers Failure'.
- Buttons:** 'Submit' and 'Cancel' buttons.
- Footer:** A checkbox labeled 'Auto Popup' which is checked.

On the left side, there is a navigation menu with categories: SYSTEM STATUS, DEVICE INFORMATION, QUICK SETTINGS, QUERY, MAINTENANCE, CONFIGURATION, Auto Configuration, Site Info Modification, Equipment Info Modification, Signal Information Modification, Alarm Suppression (highlighted), PLC, and Alarm Relays. Below the menu are two tables:

System Specifications	
System Name	ACU+
Rectifiers	4 Rectifiers

Controller Specifications	
Product Model	M820D
Serial Num	03110300144
Hardware Version	A03
Software Version	3.02
Configuration Version	ESNA_DEFAULT

At the bottom right, there is a copyright notice: '© 2011 Emerson Electric, Co. All rights reserved.'

4.8.6 PLC Sub-Menu

Allows you to configure the PLC functions of the Controller.

The following shows the PLC sub-menu.

2012-03-07 14:01:39 | LOGOUT

EMERSON Network Power Site: Emerson NETSURE ACU+ Controller

SYSTEM STATUS
 DEVICE INFORMATION
 QUICK SETTINGS
 QUERY
 MAINTENANCE
 CONFIGURATION
 Auto Configuration
 Site Info Modification
 Equipment Info Modification
 Signal Information Modification
 Alarm Suppression
PLC
 Alarm Relays

System Specifications
 System Name ACU+
 Rectifiers 4 Rectifiers

Controller Specifications
 Product Model M820D
 Serial Num 03110300144
 Hardware Version A03
 Software Version 3.02
 Configuration Version ESNA_DEFAULT

Operator	Input1			Input2			Parameter1	Parameter2	Output			Delete
	Equipment/ Register	Signal Type	Signal Name	Equipment/ Register	Signal Type	Signal Name			Equipment/ Register	Signal Type	Signal Name	
OR	Rect Group	Alarm	Multi-Rect Fail	Rect Group	Alarm	Rectifier Lost	-	-	EIB 1	Control	Relay Output 11	Delete
OR	Conv Group	Alarm	Multi-Conv Fail	Conv Group	Alarm	Converter Lost	-	-	EIB 1	Control	Relay Output 9	Delete

Add

SYMBOL INFORMATION

1:R, which defines a Register.	Usage: R(Register_ID); 0 = < Register_ID <= 99
2:P, which defines a Parameter.	Usage: P(The Value)
3:SET, which represent the SET command.	Usage: SET __ Parameter1 _ Output
4:AND, which represent the AND command.	Usage: AND Input1 Input2 __ Output
5:OR, which represent the OR command.	Usage: OR Input1 Input2 __ Output
6:NOT, which represent the NOT command.	Usage: NOT Input1 __ _ Output
7:XOR, which represent the XOR command.	Usage: XOR Input1 Input2 __ Output
8:GT, which represent the Greater Than command.	Usage: GT Input1 _ Parameter1 Parameter2 Output
9:LT, which represent the Less Than command.	Usage: LT Input1 _ Parameter1 Parameter2 Output
10:DS, which represent the Delay command.	Usage: DS Input1 _ Parameter1 _ Output

LIMITATION

All output signal values must be of the type enum, and it can't be an alarm signal. LT and GT's Input1 value type must be F,U or L type.

Auto Popup

© 2011 Emerson Electric, Co. All rights reserved.

Operation

The PLC function normally runs every 10 seconds. It starts by executing the first line and stores the result in the output signal/register. Then executes the next line and continues executing line by line until it reaches the end. The PLC function will be stopped if the ACU+ is set to Manual Mode.

Procedure

- 1) Click the *ADD* button and the window below is shown.

PLC Configuration							
Operator	Signal <input checked="" type="radio"/> Input1 Register <input type="radio"/>			Parameter1	Signal <input checked="" type="radio"/> Output Register <input type="radio"/>		
	Equipment Name/Register	Signal Type	Signal Name		Equipment Name/Register	Signal Type	Signal Name
	Power System	Sampling	System Voltage				
OR	Signal <input checked="" type="radio"/> Input2 Register <input type="radio"/>			Parameter2	Power System	Control	Relay Output 1
	Power System	Sampling	System Voltage				

Column Descriptions

- **Operator:** The Operator column selects the type of function that will be performed. The list of Operators is shown in the Symbol Information table (from line 3 and down) in the previous PLC screen.
 - **Input 1:** The Input 1 column is divided into the following three sub-columns.
 - a) **EquipName/Register:** This column shows the Equipment that the signal to be selected in c) below is associated with. (Equipment is not necessarily connected to a physical device. An Equipment can be connected to several physical devices and vice versa.)
The Equipment can be replaced by a Register. Every Register is given a unique number between 0 and 99. A Register works as a temporary storage place that will be cleared after every run of the PLC function.
 - b) **Signal Type:** This column shows the type of signal to be selected in c) below.
The ACU+ has four different signal types:
 - Sample (measured or calculated values, status).
 - Control (control of different functions or events).
 - Setting (different kind of settings).
 - Alarm (alarms, these signals will only be activated if the alarm category is set to anything else than NA).
 - c) **Signal Name:** You select the signal from this column. Signals that are shown in the drop-down list box are based on your selections in a) and b) above.
 - **Input 2:** (See Input 1 above.)
 - **Param 1:** This column shows if any parameter is used.
A parameter is just a way to enter a value, which can be used in compares with signals.
 - **Param 2:** (See Param 1 above.)
 - **Output:** The Output column is divided in three sub-columns, which has the same information as for the Inputs.
- 2) Choose the type of Operator. The web page will disable some boxes that are not applicable for the type of Operator.

PLC Configuration							
Operator	Signal <input checked="" type="radio"/> Input1 Register <input type="radio"/>			Parameter1	Signal <input checked="" type="radio"/> Output Register <input type="radio"/>		
	Equipment Name/Register	Signal Type	Signal Name		Equipment Name/Register	Signal Type	Signal Name
<input type="checkbox"/> OR <input checked="" type="checkbox"/> OR <input type="checkbox"/> AND <input type="checkbox"/> GT <input type="checkbox"/> DS <input type="checkbox"/> SET <input type="checkbox"/> XOR <input type="checkbox"/> NOT <input type="checkbox"/> LT	Power System	Sampling	System Voltage				
		—	—				
	Signal <input checked="" type="radio"/> Input2 Register <input type="radio"/>			Parameter2	Power System	Control	Relay Output 1
	Power System	Sampling	System Voltage				
		—	—				

- 3) Select Signal or Register for Input 1.
- 4) Enter either the register number or choose the equipment, signal type, and signal name. The format for entering a register is R(x), where x is the number of the register.
- 5) Setup Input 2 in the same way as Input 1 if it's not disabled.
- 6) Enter Param 1 and Param 2 if they are not disabled. The format for entering a parameter is P(x), where x is the value.
- 7) Select Signal or Register for Output.
- 8) Enter either the register number or choose the equipment, signal type, and signal name.
- 9) Click the *ADD* button in the bottom of the window.
- 10) Reboot the ACU+. See "4.7.7. Restore Factory Defaults Sub-Menu".

4.8.7 Alarm Relay Sub-Menu

Allows you to map system alarms to the alarm relays.

Select the device to display the system alarms associated to it. Also displayed is the alarm relay number assigned to this alarm. To modify the alarm relay number, click on the “Modify” button for that alarm signal.

“NA” means there is no related relay number.

EMERSON Network Power 2012-03-07 14:02:16 | LOGOUT

Site: Emerson **NETSURE** ACU+
Controller

SYSTEM STATUS
DEVICE INFORMATION
QUICK SETTINGS
QUERY
MAINTENANCE
CONFIGURATION
Auto Configuration
Site Info Modification
Equipment Info Modification
Signal Information Modification
Alarm Suppression
PLC
Alarm Relays

System Specifications

System Name	ACU+
Rectifiers	4 Rectifiers

Controller Specifications

Product Model	M820D
Serial Num	03110300144
Hardware Version	A03
Software Version	3.02
Configuration Version	ESNA_DEFAULT

Alarm Relays

Please select standard equipment:

Standard Equipment Name: Power System

Alarm Signal ID	Alarm Signal Name	Alarm Relay Number	New Relay Number	Modify
1	Supervision Unit Fault	NA	Please Select	Modify
2	CAN Communication Failure	NA	Please Select	Modify
10	Outgoing Alarms Blocked	NA	Please Select	Modify
11	Maintenance Time Limit Alarm	NA	Please Select	Modify
13	Config Error(Backup Config)	NA	Please Select	Modify
14	Config Error(Default Config)	NA	Please Select	Modify
15	Imbalance System Current	NA	Please Select	Modify
16	Over Load	NA	Please Select	Modify
40	SPD	NA	Please Select	Modify
41	EStop EShutdown	NA	Please Select	Modify
18	System Temp 1 Not Used	NA	Please Select	Modify
19	System Temp 2 Not Used	NA	Please Select	Modify
20	System Temp3 Not Used	NA	Please Select	Modify
21	IB2 Temp 1 Not Used	NA	Please Select	Modify
22	IB2 Temp2 Not Used	NA	Please Select	Modify
42	EIB Temp1 Not Used	NA	Please Select	Modify
43	EIB Temp2 Not Used	NA	Please Select	Modify
9	System Temp 1 Sensor Fault	NA	Please Select	Modify
25	System Temp 2 Sensor Fault	NA	Please Select	Modify

Auto Popup

© 2011 Emerson Electric, Co. All rights reserved.

CHAPTER 5. ACCESSING THE CONTROLLER VIA A NETWORK MANAGEMENT SYSTEM (NMS)

5.1 General

The Controller has an SNMP agent function.

Users can use a Network Management System (NMS) to do following operations:

- Query the operation status and input/output signals of the devices connected to the Controller.
- Browse the active alarms.

When the Controller generates alarms, the SNMP agent can notify the preset NMS through TRAPS automatically.

5.2 NMS Supported by SNMP Agent

The SNMP agent of the Controller supports SNMPv2c.

All the NMS that supports SNMPv2c can be used to access the Controller. The NMS includes HP OpenView, IBM NetView, Novell ManageWise, SunNet Manager and so on. SNMP is a technology used for network management. The technology is based on implementing an information base called MIB (Managed Information Base). This MIB contains parameters that are of interest from a management perspective. All LAN connected equipment that support SNMP also support a default MIB called MIB-II.

The SNMP Agent responds to requests received via the SNMP protocol and also actively sends TRAPS to a specified manager when certain MIB values change state. This is used to actively inform a manager when an alarm situation is recognized.

5.3 MIB Installation

5.3.1 Installation

The Controller's MIB is named "Netsure_ESNA.mib". Contact your Emerson representative for the location on the Web to download the MIB file.

Use the MIB loading function of NMS to load the MIB database, refer to the corresponding NMS User Manual for the detailed loading method.

5.3.2 Contents of the Controller's MIB

The contents of the MIB supported by the Controller's SNMP agent and the OID are listed in Table 5. For the details, refer to the file named "Netsure_ESNA.mib".

Ident Group	Controller Ident Group	
identManufacturer	The name of the equipment manufacturer.	R
identModel	The manufacturers model designation of the power system.	R
identControllerFirmwareVersion	The firmware (software) version of the Controller.	R
identName	The name of the power plant. This object should be set by the administrator.	R/W
System Group	Controller System Value Group	
systemStatus	Status of the complete plant (highest alarm). One of... (1) unknown - status has not yet been defined (2) normal - there are no activated alarms (3) warning - OA, lowest level of 'abnormal' status (4) minor - A3 (5) major - MA (6) critical - CA, highest level of 'abnormal' status (7) unmanaged (8) restricted (9) testing (10) disabled	R
systemVoltage	System voltage, stored as mV.	R
systemCurrent	System current, stored as mA.	R
systemUsedCapacity	Used capacity, stored as percentage of the total capacity.	R
psBattery Group	Power System Battery Group	
psBatteryVoltage	Battery voltage, stored as mV.	R
psBatteryCurrent	Battery current, stored as mA.	R
psInput Group	Power System Input Group	
psInputLineAVoltage	The AC line A voltage, stored as mV.	R
psInputLineBVoltage	The AC line B voltage, stored as mV.	R
psInputLineCVoltage	The AC line C voltage, stored as mV.	R
psTemperature Group	Power System Temperature Group	
psTemperature1	The first route temperature, stored as 0.001 Celsius degree.	R
psTemperature2	The second route temperature, stored as 0.001 Celsius degree.	R

psStatusCommunication	The status of communication with the Power System. (1) unknown (2) normal (3) interrupt indicates some errors occurred between Power System and agent	R
psStatusBatteryMode	The status of battery modes. (1) unknown (2) FloatCharging (3) ShortTest (4) EqualizeChargingForTest (5) ManualTesting (6) PlanTesting (7) ACFailTesting (8) ACFail (9) ManualEqualizeCharging (10) AutoEqualizeCharging (11) CyclicEqualizeCharging (12) MasterEqualizeCharging (13) MasterBatteryTesting	R
SM Series Group	Supervisory Module Group	
psSMACNumber	The number of SM AC module.	R
psSMBATNumber	The number of SM BAT module.	R
psSMIONumber	The number of SM IO module.	R
Alarm Trap Group	Controller Alarm Trap Group	
alarmLastTrapNo	The sequence number of last submitted alarm trap.	R
alarmTrapTable (alarmTrapEntry)	Table holding information about the submitted alarm traps. alarmTrapEntry is the entry (conceptual row) in the alarmTrapTable.	R
alarmTrapNo	The unique sequence number of this alarm trap.	R
alarmTime	Date and time when event occurred (local time), including timezone if supported by Controller.	R
alarmStatusChange	The type of alarm change. One of... (1) activated (2) deactivated	R
alarmSeverity	The severity of the alarm. One of... (1) warning - OA, lowest level of alarm severity (2) minor - A3 (3) major - MA (4) critical - CA, highest level of alarm severity	R
alarmDescription	Free-text description of alarm.	R

alarmType	Alarm type, i.e. an integer specifying the type of alarm.	R
Traps	Alarm Traps Info	
--	The SNMP agent can send the active alarms to the specified NMS and the User can define the lowest severity of the NMS accepted alarms.	--

Table 5
 Contents of the Controller's MIB

In Table 5, R means OID is read-only (GET), and R/W means OID can be read and modified (GET/SET).

5.4 Accessing the Controller through an NMS

5.4.1 Apply Administrative Authority

In order to use NMS to manage the devices connected to the Controller, the administrative authority needs to be applied for the NMS, that is, add the NMS information to the access list of SNMP agent.

Add NMS through Web Browser

Refer to “*Chapter 4. WEB Interface Menus*” for the method of adding NMS.

CHAPTER 6. REPLACEMENT PROCEDURES

6.1 ACU+ Controller Replacement

Warning: ACU+ CONTROLLER HANDLING.

Installation or removal of the ACU+ Controller requires careful handling. To avoid possibility of ACU+ Controller damage from static discharge, a static wrist strap grounded through a one megohm resistor should always be worn when handling the ACU+ Controller. ESD-protective packaging material must also be used when carrying/shipping the ACU+ Controller.

Note: Depending on your network security settings, when you remove a device that is connected to your network and assign the same IP address to the replacement device, you may not be allowed to communicate with the replacement device over the network. Contact your network administrator for assistance.

The ACU+ Controller is hot swappable. It can be removed and installed with the system operating and without affecting the output bus.

Procedure

- 1) Before performing this procedure, ensure the replacement ACU+ Controller contains the same configuration file as the existing ACU+ Controller. Refer to the Configuration Label on the side of the replacement ACU+ Controller for the Configuration Part Number. If the existing Controller is operational, navigate the menus to view its configuration file (MAIN SCREEN/ESC/ENT/ENT).

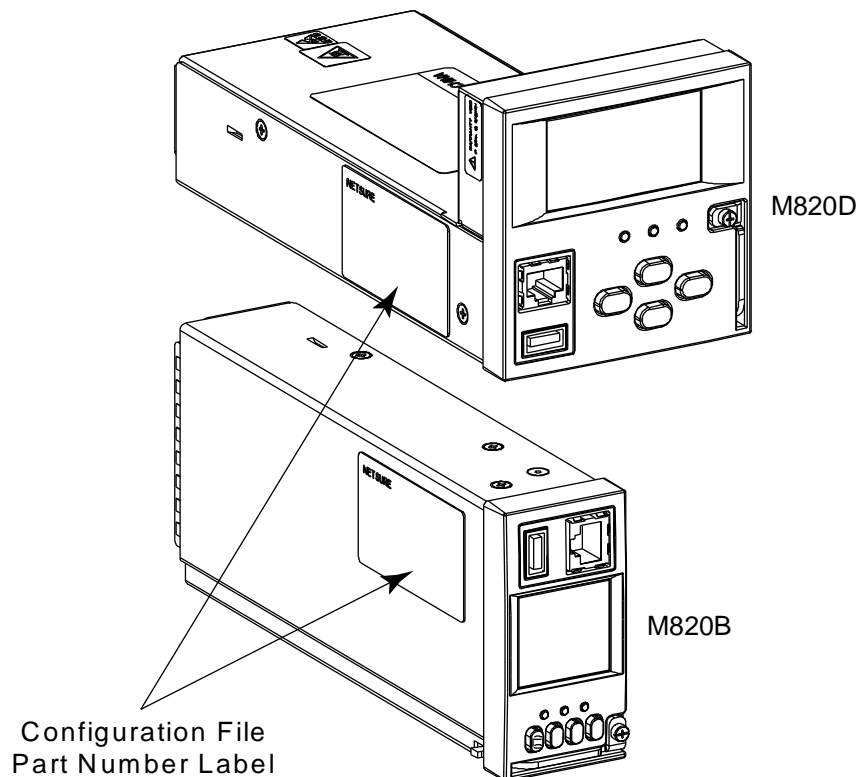

Figure 9
ACU+ Controller Configuration Label Location

- 2) Performing this procedure may activate external alarms. Do one of the following. If possible, disable these alarms. If these alarms cannot be easily disabled, notify the appropriate personnel to disregard any future alarms associated with this system while this procedure is being performed.

- 3) Connect an approved grounding strap to your wrist. Attach the other end to a suitable ground.
- 4) Loosen the captive fastener securing the latch mechanism to the front of the ACU+ Controller. Pull the latch mechanism away from the ACU+ Controller (this will retract the latch mechanism located on the bottom of the ACU+ Controller). This unlocks the ACU+ Controller from the shelf. Refer to Figure 10.
- 5) Slide the ACU+ Controller completely from the shelf.
- 6) Loosen the captive fastener securing the latch mechanism to the front of the replacement ACU+ Controller. Pull the latch mechanism away from the ACU+ Controller (this will retract the latch mechanism located on the bottom of the ACU+ Controller).
- 7) Slide the ACU+ Controller completely into its mounting position.
- 8) Push the latch mechanism into the front panel of the ACU+ Controller, and secure by tightening the captive fastener. This locks the ACU+ Controller securely to the shelf.
- 9) Wait for the Controller to finish booting and verify that the complete system operates normally.
- 10) Enable the external alarms, or notify appropriate personnel that this procedure is finished.
- 11) Ensure that there are no local or remote alarms active on the system.

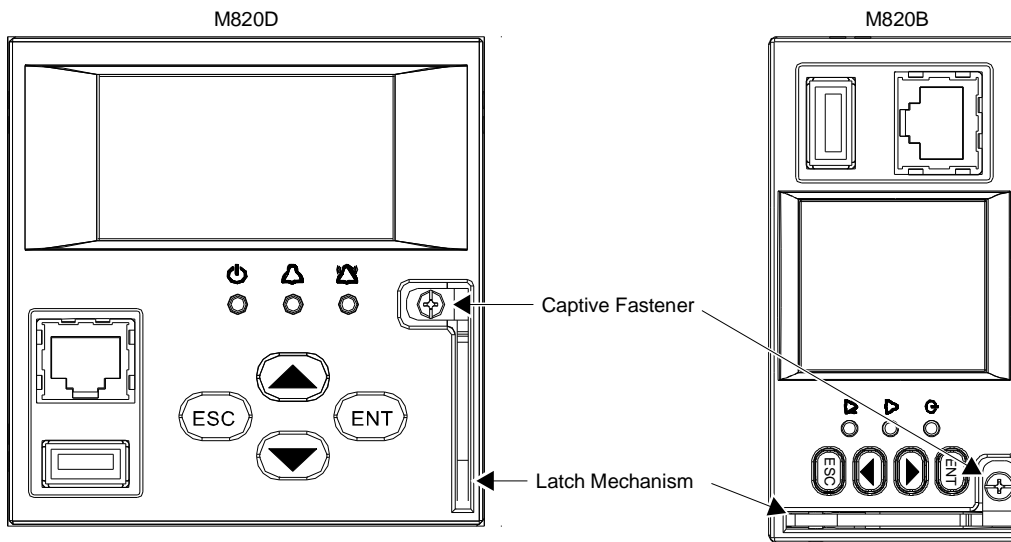

Figure 10
Latch Mechanism on the ACU+ Controller

CHAPTER 7. SPECIFICATIONS

Input Voltage Range: 19 to 60 VDC.

Power Consumption: 5W.

Operating Temperature Range: -40°C (-40°F) to +75°C (+167°F).

Humidity: Capable of operating in an ambient relative humidity range of 0% to 90%, non-condensing.

Dimensions:

- **Model M820B:** 42mm (H) x 86.6mm (W) x 211.5mm (D)
1.65" (H) x 3.41" (W) x 8.33" (D)
- **Model M820D:** 86.6mm (H) x 86.8mm (W) x 211.5mm (D)
3.41" (H) x 3.41" (W) x 8.33" (D)

Weight: < 1kg (2.2 lbs).

Front Panel Display: LCD with 4 x 16 (Model M820D) or 8 x 16 (Model M820B) characters.

Indicators:

- Status (Green)
- Minor Alarm (Yellow)
- Critical / Major Alarm (Red)

Local and Remote Access Passwords: Refer to "2.2 Passwords and Access Levels".

Inputs and Outputs: Connection points provided on ACU+ Interface Board(s) mounted in the system. Refer to your system documentation.

Factory Default Setpoints: Refer to the Configuration Drawing (C-drawing) furnished with your system for a list of factory default values.

This page is intentionally blank.

REVISION RECORD

Issue	Change Number (ECO)	Description of Change
AA	LLP214923	New
AB	LLP215392	Revised for version 2.23.
AC	LLP215822	Revised for version 2.25.
AD	LLP216384	Revised for Version 3.00.
AE	LLP216700	Revised for Version 3.02.
AF	LLP217311	Revised for Version 3.04. Section "2.5.36 Setting External Shunts (connected to the SM-DU+ Assembly)" added.
AG	LLP217741	Revised for Version 4.00 (Lithium Ion Battery Configuration support).
AH	LLP218449	Revised for Version 4.02 (Converter Menus Updated).

NetPerform™ Optimization Services

At Emerson Network Power, we understand the importance of reliable equipment – it's critical to both your business and your bottom line. That is why we offer a wide array of services to meet all of your network infrastructure needs.

Customer Service (Pre-Shipment)

Email	CustomerService.ESNA@Emerson.com	Pricing and availability ^[1,2] , purchase orders, expediting requests and order tracking. Ask for your company's dedicated Customer Service Associate.
Phone	1.800.800.1280 option 2	

Customer Support Center (Post-Shipment)

Email	ESNACustomerSupportCenter@Emerson.com	After an order has shipped, contact our Customer Support Center with related questions, concerns or claims.
Phone	1.956.661.6867	

Account Management

Email	AccountManagement.ESNA@Emerson.com	Provides quotes and bid responses for custom configured ^[2] DC power systems and outside plant enclosures for customers and channel partners (Reps, VARs & Distributors).
Phone	1.800.800.1280 option 3	

Spare Parts

Email	DCpower.Spares@Emerson.com OSP.Spares@Emerson.com	Pricing and purchase orders for spare parts, including but not limited to breakers, cables, fuses, rectifier fans, misc. breaker and fuse panels, enclosure fans, doors and switches, etc.
Phone	1.800.800.1280 option 5	

DC Power Depot Repair

Email	DCpower.Repair@Emerson.com	Creates and processes RMAs for depot repair and refurbishment. Determines repair and refurbishment lead times and pricing based on warranties/contractual agreements. Provides repair shipping information and status.
Phone	1.800.800.1280 option 6	

Technical Support

Email	DCpower.TAC@Emerson.com OSP.TAC@Emerson.com	Answers technical product and system questions; determines status of warranties and contractual agreements for repair.
Phone	1.800.800.5260	

^[1] Contact Account Management for custom-configurations.

^[2] Contact DC Power Spare Parts for parts and accessories.

For More Information

To learn more about service offerings from Emerson Network Power, please contact your sales representative, call 1-800-800-1280 option 7, email ES.Services@Emerson.com or visit EmersonNetworkPower.com/EnergySystems.



The information contained in this document is subject to change without notice and may not be suitable for all applications. While every precaution has been taken to ensure the accuracy and completeness of this document, Emerson Network Power, Energy Systems, North America, Inc. assumes no responsibility and disclaims all liability for damages resulting from use of this information or for any errors or omissions. Refer to other local practices or building codes as applicable for the correct methods, tools, and materials to be used in performing procedures not specifically described in this document.

The products covered by this instruction manual are manufactured and/or sold by Emerson Network Power, Energy Systems, North America, Inc. This document is the property of Emerson Network Power, Energy Systems, North America, Inc. and contains confidential and proprietary information owned by Emerson Network Power, Energy Systems, North America, Inc. Any copying, use or disclosure of it without the written permission of Emerson Network Power, Energy Systems, North America, Inc. is strictly prohibited.

Names of companies and products are trademarks or registered trademarks of the respective companies. Any questions regarding usage of trademark names should be directed to the original manufacturer.

[EmersonNetworkPower.com/EnergySystems \(North America\)](http://EmersonNetworkPower.com/EnergySystems(NorthAmerica))
[EmersonNetworkPower.eu/EnergySystems \(EMEA\)](http://EmersonNetworkPower.eu/EnergySystems(EMEA))

© Emerson Network Power Energy Systems North America 2013.

Business-Critical Continuity™, Emerson Network Power™, the Emerson Network Power logo, Emerson® and Consider it Solved are service marks and trademarks of Emerson Electric Co. EnergyMaster™, eSure™, NetPerform™, NetReach™, NetSpan™, NetSure™ and NetXtend™ are trademarks of Emerson Network Power Energy Systems North America.



EMERSON. CONSIDER IT SOLVED.™